



# SHOWBOX

BATTERY POWERED ALL-IN-ONE PERFORMANCE RIG  
WITH BREAKAWAY MIX CONTROL

## OWNER'S MANUAL



# Important Safety Instructions

1. Read these instructions.
2. Keep these instructions.
3. Heed all warnings.
4. Follow all instructions.
5. Do not use this apparatus near water.
6. Clean only with a dry cloth.
7. Do not block any ventilation openings. Install in accordance with the manufacturer's instructions.
8. Do not install near any heat sources such as radiators, heat registers, stoves, or other apparatus (including amplifiers) that produce heat.
9. Protect the power cord from being walked on or pinched particularly at plugs, convenience receptacles, and the point where they exit from the apparatus.
10. Only use attachments/accessories specified by the manufacturer.
11. Use only with a cart, stand, tripod, bracket, or table specified by the manufacturer, or sold with the apparatus. The apparatus may also be placed on the ground in wedge position. When a cart is used, use caution when moving the cart/apparatus combination to avoid injury from tip-over.
12. Unplug this apparatus during lightning storms or when unused for long periods of time.
13. Refer all servicing to qualified service personnel. Servicing is required when the apparatus has been damaged in any way, such as power-supply cord or plug is damaged, liquid has been spilled or objects have fallen into the apparatus, the apparatus has been exposed to rain or moisture, does not operate normally, or has been dropped.
14. This apparatus shall not be exposed to dripping or splashing, and no object filled with liquids, such as vases or beer glasses, shall be placed on the apparatus.
15. Do not overload wall outlets and extension cords as this can result in a risk of fire or electric shock.



**CAUTION**

RISK OF ELECTRIC SHOCK! DO NOT OPEN!

CAUTION: TO REDUCE THE RISK OF ELECTRIC SHOCK DO NOT REMOVE COVER (OR BACK). NO USER-SERVICEABLE PARTS INSIDE. REFER SERVICING TO QUALIFIED PERSONNEL.

- The lightning flash with arrowhead symbol within an equilateral triangle is intended to alert the user to the presence of uninsulated "dangerous voltage" within the product's enclosure, that may be of significant magnitude to constitute a risk of electric shock to persons.
- The exclamation point within an equilateral triangle is intended to alert the user of the presence of important operating and maintaining (servicing) instructions in the literature accompanying the appliance.

**16. NOTE:** This equipment has been tested and found to comply with the limits for a Class B digital device, pursuant to part 15 of the FCC Rules. These limits are designed to provide reasonable protection against harmful interference in a residential installation. This equipment generates, uses, and can radiate radio frequency energy and, if not installed and used in accordance with the instructions, may cause harmful interference to radio communications. However, there is no guarantee that interference will not occur in a particular installation. If this equipment does

- WARNING** — To reduce the risk of fire or electric shock, do not expose this apparatus to rain or moisture.
- CAUTION** — To prevent electric shock hazard, do not connect to mains power supply while grille is removed.
- WARNING** — The battery (battery or batteries or battery pack) shall not be exposed to excessive heat such as sunshine, fire or the like.
- CAUTION** — Danger of explosion if battery is incorrectly replaced. Replace only with the same or equivalent type.
- If the product is subjected to static electrical interference, it is necessary to manually restart the product which is within the design scope of the product.

cause harmful interference to radio or television reception, which can be determined by turning the equipment off and on, the user is encouraged to try to correct the interference by one or more of the following measures:

- Reorient or relocate the receiving antenna.
- Increase the separation between the equipment and the receiver.
- Connect the equipment into an outlet on a circuit different from that to which the receiver is connected.
- Consult the dealer or an experienced radio/TV technician for help.

**CAUTION:** Changes or modifications to this device not expressly approved by LOUD Audio, LLC could void the user's authority to operate the equipment under FCC rules.

17. Any changes or modifications not expressly approved by the party responsible for compliance could void the user's authority to operate the equipment. This equipment complies with FCC radiation exposure limits set forth for an uncontrolled environment. This equipment should be installed and operated with minimum distance 20cm between the radiator & your body.
18. For pluggable equipment, the socket-outlet shall be easily accessible.
19. The maximum ambient temperature during use of the appliance must not exceed 45° C.
20. Operation frequency: 2400MHz – 2483.5MHz
21. This apparatus has been designed with Class-I construction and must be connected to a mains socket outlet with a protective earthing connection (the third grounding prong).
22. This apparatus does not exceed the Class A/Class B (whichever is applicable) limits for radio noise emissions from digital apparatus as set out in the radio interference regulations of the Canadian Department of Communications.
 

**ATTENTION** — *Le présent appareil numérique n'émet pas de bruits radioélectriques dépassant les limites applicables aux appareils numériques de class A/de class B (selon le cas) prescrites dans le règlement sur le brouillage radioélectrique édicté par les ministères des communications du Canada.*
23. This device complies with Part 15 of the FCC Rules [and contains license-exempt transmitter(s)/receiver(s) that comply with Innovation, Science and Economic Development Canada's license-exempt RSS(s)]. Operation is subject to the following two conditions:
  - (1) this device may not cause harmful interference, and
  - (2) this device must accept any interference received, including interference that may cause undesired operation.

L'émetteur/récepteur exempt de licence contenu dans le présent appareil est conforme aux CNR d'Innovation, Sciences et Développement économique Canada applicables aux appareils radio exempts de licence. L'exploitation est autorisée aux deux conditions suivantes:

- (1) l'appareil ne doit pas produire de brouillage, et
- (2) l'appareil doit accepter tout brouillage radioélectrique subi, même si le brouillage est susceptible d'en compromettre le fonctionnement.

**24.** Exposure to extremely high noise levels may cause permanent hearing loss. Individuals vary considerably in susceptibility to noise-induced hearing loss, but nearly everyone will lose some hearing if exposed to sufficiently intense noise for a period of time. The U.S. Government's Occupational Safety and Health Administration (OSHA) has specified the permissible noise level exposures shown in the following chart.

According to OSHA, any exposure in excess of these permissible limits could result in some hearing loss. To ensure against potentially dangerous exposure to high sound pressure levels, it is recommended that all persons exposed to equipment capable of producing high sound pressure levels use hearing protectors while the equipment is in operation. Ear plugs or protectors in the ear canals or over the ears must be worn when operating the equipment in order to prevent permanent hearing loss if exposure is in excess of the limits set forth here:

Duration, per day in hours	Sound Level dBA, Slow Response	Typical Example
8	90	Duo in small club
6	92	
4	95	Subway Train
3	97	
2	100	Very loud classical music
1.5	102	
1	105	Ty screaming at Troy about deadlines
0.5	110	
0.25 or less	115	Loudest parts at a rock concert



**Correct disposal of this product:** This symbol indicates that this product should not be disposed of with your household waste, according to the WEEE directive (2012/19/EU) and your national law. This product should be handed over to an authorized collection site for recycling waste electrical and electronic equipment (EEE). Improper handling of this type of waste could have a possible negative impact on the environment and human health due to potentially hazardous substances that are generally associated with EEE. At the same time, your cooperation in the correct disposal of this product will contribute to the effective usage of natural resources. For more information about where you can drop off your waste equipment for recycling, please contact your local city office, waste authority, or your household waste disposal service.

# Table of Contents

**Important Safety Instructions.....2**

---

**Table of Contents .....3**

---

**Chapter 1 : Welcome.....6**

---

**Introduction.....6**  
**Features .....6**  
**Things to Remember.....6**  
**About This Guide .....7**  
**Getting Started.....7**

**Chapter 2 : ShowBox Rear Panel Features .....8**

---

**Introduction.....8**  
**Power Connector .....8**  
**Power Switch.....8**  
**XLR Mic Input Jacks [Channels 1 and 3] .....9**  
**1/4" Input Jacks [Channels 2 and 4] .....9**  
**1/4" Stereo Line Input Jacks [Channel 5/6] .....10**  
**Bluetooth Button and LED .....10**  
**1/8" Stereo Line Input (Aux) Jack .....11**  
**1/4" External FX Send/Return Jacks.....11**  
**1/4" Footswitch Jack and (Optional) Footswitch.....12**  
**1/4" Headphone Output Jack .....12**  
**Mix Out Jack .....13**  
**USB-C Interface .....13**  
**Micro SD Port.....14**  
**Front LED Button and LED.....14**  
**Feedback Eliminator Button and LED .....14**  
**Outdoor Mode Button and LED .....15**  
**PA Mode Button and LED .....15**  
**Battery Charge Status LED .....15**  
**Factory Reset .....15**  
**Breakaway Mixer Data Port .....16**  
**Battery Replacement .....16**

**Chapter 3 : ShowBox Breakaway Mixer ..... 18**

**Introduction..... 18**  
**Breakaway Mixer Data Port ..... 18**  
**USB-C Charging Thru Port..... 19**

**CHANNEL select ..... 19**  
**Channel Select Buttons ..... 19**

**CHANNEL control ..... 19**  
**Channel Volume and Gain Knob..... 19**  
**Setting Auto-Gain on ShowBox ..... 20**  
**Channel Equalization (EQ) Knobs ..... 21**  
**Hi EQ Knobs ..... 21**  
**Mid EQ Knobs ..... 21**  
**Low EQ Knobs..... 21**  
**Compressor Knob ..... 22**  
**Presence Knob..... 23**  
**FX Knobs ..... 24**  
**Selecting FX on ShowBox ..... 24**  
**Tuner ..... 25**  
**Snapshots ..... 26**  
**Accessing Snapshots on ShowBox ..... 26**  
**External FX Loop Knob ..... 26**

**LOOP control ..... 27**  
**Looper Button ..... 27**  
**Working the Looper on ShowBox ..... 27**  
**Loop Level Knob ..... 28**

**MAIN control ..... 29**  
**Main Volume Knob and Mute Button..... 29**  
**Headphones Volume Knob..... 29**  
**Micro SD Button and LED ..... 30**  
**Recording to micro SD card on ShowBox ..... 30**  
**Battery Level Indicator LED..... 31**

**Chapter 4 : Protection Circuitry ..... 32**

**Introduction..... 32**  
**Limiting..... 32**  
**Overexcursion Protection ..... 32**  
**Thermal Protection ..... 32**  
**AC Power ..... 33**  
**Care and Maintenance ..... 33**

**Chapter 5 : Placement ..... 34**

**Introduction..... 35**  
**Connecting the Breakaway Mixer to a Mic Stand..... 35**  
**Room Acoustics..... 35**

**Hookup Diagrams ..... 36**

---

**Hookup Diagrams > Singer-Songwriter / Busker ..... 36**  
**Hookup Diagrams > Karaoke Enthusiasts ..... 37**  
**Hookup Diagrams > Bands ..... 38**  
**Hookup Diagrams > Daisy-Chaining..... 39**

**Appendix A : Service Information..... 40**

---

**Troubleshooting..... 40**  
**Repair ..... 41**

**Appendix B : Technical Information ..... 42**

---

**Specifications ..... 42**  
**ShowBox Dimensions ..... 45**  
**ShowBox Block Diagram ..... 46**

**Appendix C : Table of Effects Presets ..... 47**

---

**FX1 ..... 47**  
**FX2 ..... 48**

**Warranty Statement ..... 50**

---

**Fin ..... 53**

---

## Chapter 1 : Welcome

---

### Introduction

Hello everyone! This is the ShowBox Owner's Manual. This document contains detailed information about the ShowBox... we hope you like it!

Set up in seconds with Mackie ShowBox, the battery-powered all-in-one performance rig that makes it easy to get great live sound anywhere.

ShowBox offers all the audio inputs for solo gigs and small bands, replacing instrument amps and PA speakers and adding effects you can tweak from your mic stand with the breakaway controller.

You can even take your performance online with a USB-C interface for streaming and recording, while playing over backing tracks via Bluetooth®.

With essential performance features and plenty more to discover, Mackie ShowBox lets you carry your whole rig in one trip from the car.

So there you have it. Again, we hope you like it. If you have any questions or comments about this Owner's Manual (or other Mackie documentation), please don't hesitate to contact us:

- 1-800-898-3211 (Monday through Friday, normal business hours, Pacific Time)
- [www.mackie.com/support-contact](http://www.mackie.com/support-contact)

### Features

- Breakaway Mix Control
- Inputs for Mics, Guitars, Keys and More
- 6 FX Engines (2 FX per channel)
- Stream/Record via USB-C and MicroSD
- Voicing Modes: Amp/PA, Indoor/Outdoor
- Built-in Looper and Tuner
- Bluetooth® Streaming
- Passthrough USB Charging (for mobile devices)
- Up to 12 Hours of Playtime with Included Battery

### Things to Remember

- Never listen to loud music for prolonged periods.  
Please see the Safety Instructions on page 2 for information on hearing protection.
- Save the shipping boxes and packing materials! You may need them someday. Besides, the cats will love playing in them and jumping out at you unexpectedly. Remember to pretend like you are surprised!
- Save your sales receipt in a safe place.

## About This Guide

This guide is designed to be accessible, with subsections as complete as practical to minimize having to electronically leaf back and forth looking for the whole story. The entire manual does not need to be read to figure out how to use ShowBox.

As the saying goes, “a picture tells a 1000 words”. With that thought in mind, we added quite a few illustrations, screenshots and other images throughout to accompany the text.



This icon marks information that is critically important or unique! For your own good, read and remember them.



There's an illustration of a microscope, so, of course, you're going to get more detailed information when you see this little guy. There are explanations of features and practical tips listed here.



It's a good idea to pay attention to text displayed next to a note icon, as this icon draws attention to certain features and functions relating to the usage of ShowBox.

## Getting Started

The following steps will help you set up the ShowBox quickly. If you desire a more thorough walk-through of ShowBox, there is a wealth of information in the following pages!

1. Read and understand the Important Safety Instructions on page 2.
2. Make all initial connections with the power switches OFF on all equipment.
3. Push the line cord securely into the ShowBox's connector and plug the other end into a grounded AC outlet. The ShowBox may accept the appropriate voltage as indicated near the connector. There is also a hidden compartment on the bottom of the ShowBox to place a battery. Read more about it on pages 16-17.
4. Plug signal sources into the ShowBox, such as:
  - Microphones plugged into the mic inputs.
  - Instrument level sources, such as acoustic guitars w/active pickups into the instrument inputs.
  - Line-level sources such as keyboards, drum machines, or media player plugged into the line-level inputs.
  - Smartphone paired and connected via Bluetooth.
5. Turn the ShowBox on.
6. Be sure that the volume of the input is the same as it would be during normal use.
7. Slowly bring up the main knob to a comfortable listening level.
8. Additional features: connect the breakaway mixer to the base unit (ShowBox), add internal and external effects, add EQ and comp, start a loop, and so much more!

## Chapter 2 : ShowBox Rear Panel Features

### Introduction

The breakaway mix control of ShowBox may be where all the magic happens, but nothing will happen if it can't be powered up and instruments, phones, and other things aren't connected to it, so let's start there!

The rear panel of each ShowBox is outfitted with a power connector, a power switch, a wide variety of input and output choices, and much, much more! Let's take a look at each of these features, starting with the power connector and power switch at the bottom of the ShowBox, followed by a look at the input and out jacks, then working our way around.



### Power Connector

The ShowBox may be powered in two ways:

(1) This is a standard 3-prong IEC power connector. Connect the detachable power cord (included in the packaging) to the power receptacle, and plug the other end of the power cord into an AC outlet.



Make sure that the AC power is matched to the AC power indicated on the rear panel (near the IEC receptacle).



**Warning:** Disconnecting the plug's ground pin is dangerous. Don't do it!

(2) The ShowBox may also be powered via a portable, rechargeable battery. It may be accessed by removing the battery compartment cover from the bottom of ShowBox. There is more information on pages 16-17.



### Power Switch

Located next to the power connector is the power switch. Press the top of this rocker switch in to turn the ShowBox on and press the bottom of this switch in to turn it off.



### XLR Mic Input Jacks [Channels 1 and 3]

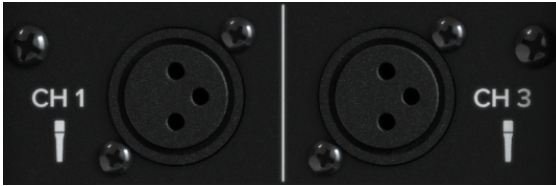

These mono female XLR connectors accept a balanced mic or line level input from almost any type of source. These mic preamps feature higher fidelity and headroom rivaling any standalone mic preamp on the market today. These circuits are excellent at rejecting hum and noise.

Professional ribbon, dynamic, and condenser mics all sound excellent through these inputs. The mic / line inputs will handle any kind of level you can toss at them, without overloading.

The gain should be set to the hottest value possible without clipping or distorting the incoming signal. This can be achieved automatically by using the auto gain feature. More information regarding auto gain may be found on pages 19-20.

They are wired as follows, according to standards specified by the AES (Audio Engineering Society).

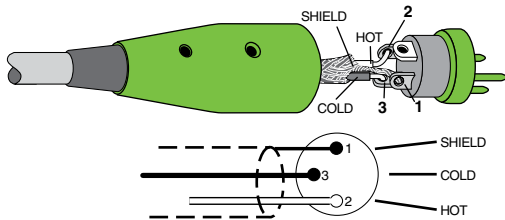

#### XLR Balanced Wiring:

- Pin 1 = Shield (ground)
- Pin 2 = Positive (+ or hot)
- Pin 3 = Negative (- or cold)



**NEVER** connect the output of an amplifier directly to a ShowBox's input jack. This could damage the input circuitry and we wouldn't want that now, would we?

### 1/4" Input Jacks [Channels 2 and 4]

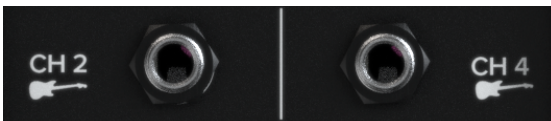

Channels 2 and 4 may accept 1/4" instrument level sources. These inputs will always be Hi-Z inputs that utilize DSP for auto gain. Once a cable is plugged into an input, auto gain is used to set the appropriate gain value for the incoming signal. The gain should be set to the hottest value possible without clipping or distorting the incoming signal. This can be achieved automatically by using the auto gain feature. More information regarding auto gain may be found on pages 19-20.

To connect balanced lines to these inputs, use a 1/4" Tip-Ring-Sleeve (TRS) plug. "TRS" stands for Tip-Ring-Sleeve, the three connection points available on a stereo 1/4" or balanced phone jack or plug. TRS jacks and plugs are used for balanced signals and are wired as follows:

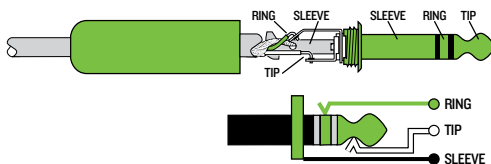

#### 1/4" TRS Balanced Mono Wiring:

- Sleeve = Shield
- Tip = Hot (+)
- Ring = Cold (-)

## 1/4" Stereo Line Input Jacks [Channel 5-6]



This dual stereo line input is designed for 1/4" TRS balanced cables. While these inputs were designed as an additional line-level instrument – synthesizer, drum machine, etc. – it may accept a CD/media player, effects device, or any other line-level instrument, as well.

If connecting a mono source, use the left (mono) input, and the mono signals will appear on both sides of the main mix.

To connect balanced lines to these inputs, use a 1/4" Tip-Ring-Sleeve (TRS) plug. The wiring diagram was presented on the previous page.

The volume of the 1/4" signal may be raised/lowered via the Channel 5-6 volume knob.



While it may look like Channels 5-6 includes the stereo 1/4" input jacks, the 1/8" aux input, and the Bluetooth connection, all three may be used simultaneously!



This input will not have access to the internal FX engine, FX loop, or compressor – and these parameters will not illuminate on the breakaway mixer. However, it will still have its own 3-band EQ.



**NEVER** connect the output of an amplifier directly to a ShowBox's input jack. This could damage the input circuitry and we wouldn't want that now, would we?

## Bluetooth Button and LED



This button will engage the channel's pairing mode, allowing the ShowBox to be seen by other Bluetooth devices such as a phone or tablet.

**Pairing and Connecting** – Press and hold the Bluetooth button to select it. The button will flash blue when selected. This is to indicate that the ShowBox and device are in pairing mode.

While the ShowBox is in pairing mode, simultaneously scan for Bluetooth devices on the phone or tablet. You should see ShowBox appear in the "available devices" list. Select it. From there, the device should indicate that it is successfully connected. Additionally, the LED button on the ShowBox will be solid blue instead of flashing. If nothing is connected to ShowBox via Bluetooth – or if the ShowBox and device are out of range – then the LED will not illuminate.

The volume of the Bluetooth signal may be raised/lowered via the Channel 5-6 volume knob.



While it may look like Channels 5-6 includes the stereo 1/4" input jacks, the 1/8" aux input, and the Bluetooth connection, all three may be used simultaneously!

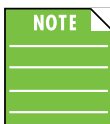

A previously paired device will auto reconnect if both the device and ShowBox are powered on and in range.



The Bluetooth may disconnect when affected by Electrostatic Discharge [ESD]. Manually reconnect the Bluetooth connection.

## 1/8" Stereo Line Input (Aux) Jack



This stereo line input is designed for 1/8" TRS balanced connections, such as a phone or tablet.

The volume of the 1/8" signal may be raised/lowered via the Channel 5-6 volume knob.



While it may look like Channels 5-6 includes the stereo 1/4" input jacks, the 1/8" aux input, and the Bluetooth connection, all three may be used simultaneously!



This input will not have access to the internal FX engine, FX loop, or compressor – and these parameters will not illuminate on the breakaway mixer. However, it will still have its own 3-band EQ.



**NEVER** connect the output of an amplifier directly to a ShowBox's input jack. This could damage the input circuitry and we wouldn't want that now, would we?

## 1/4" External FX Send/Return Jacks



That's correct, the ShowBox does come fully-equipped with effects, but if you have a guitar pedal (or fifty), they may be placed in front of the input jack or... connected via the FX loop!

In a nutshell, if the external FX send/return jacks are **NOT** used, an overdriven preamp on ShowBox will distort and compress the pedals, essentially reducing the tone to hot garbage. However, plugging a pedal board to these jacks bypasses the input – working (sort of) like an "insert" jack – after the ShowBox's overdriven preamp, but before the high-headroom power section.

The input jack at the beginning of the pedal chain connects to the SEND jack and the output jack at the end of the pedal chain connects to the RETURN jack. This allows the amp (ShowBox) and pedals to both retain their tonal characteristics. The external FX loop knob – see page 26 – lowers and raises the volume of the externally connected effects. Crank the ShowBox up without fear of ruining the glorious sounds of the attached guitar pedals.

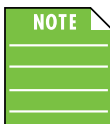

Not all pedals have to be connected via the FX send and return jacks, nor do all pedals have to be connected directly to the channel input.



Every musician has differing thoughts on what pedals go where and in what order, so listen to who you feel gives you the best information... or more importantly, just listen to your ears, and mix and match to your heart's content.



The send output jack sends a post-preamp (but pre-channel fader/DSP) signal for each channel. The external FX loop knob on each channel applies the amount of signal sent through the send output jack. The return input jack then sends the signal back into the external FX mix bus.

## 1/4" Footswitch Jack and (Optional) Footswitch



This 1/4" TRS connector is where to connect your favorite footswitch. This allows you to easily mute or un-mute the internal effects at will. Additionally, it controls the built-in looper. Almost any two-button footswitch will work... including Mackie's own ShowBox-branded footswitch (PN 2056472).



The footswitch is connected to the footswitch jack using a 1/4" TRS cable. The button on the left controls the looper and works exactly the same as if pushing the looper button on the breakaway mixer. More information about the looper and how to operate it is on pages 27-28.

The button on the right mutes and un-mutes the FX. It is akin to double-tapping the FX button(s) on the breakaway mixer... but much, much easier! More information about the FX and how to operate them is on pages 24-25, 47-48.



The FX footswitch also mutes/un-mutes any pedals connected to the external FX send and return jacks.

## 1/4" Headphone Output Jack



This 1/4" TRS connector supplies the output to stereo headphones (or a headphone amplifier). The volume is controlled via the headphones knob on the breakaway mixer. The phones output follows standard conventions:

Tip = Left channel  
Ring = Right channel  
Sleeve = Ground



**WARNING:** The headphone amp is loud and can cause permanent hearing damage. Even intermediate levels may be painfully loud with some headphones. **BE CAREFUL!** Always turn the phones level control all the way down before connecting headphones, or doing anything new that may affect the headphone volume.

Then turn it up slowly as you listen carefully.



Plugging headphones into this jack does **NOT** mute the main output. However, the main mute button does apply to the headphone out. If you want the main output muted, turn the main volume knob to the left until only the far-left LED is illuminated. The phones jack is post-channel and DSP knobs, but pre-main level knob.

## Mix Out Jack



This is a male XLR-type connector that produces a line-level summed-mono mix of all inputs (including Bluetooth). Use it to daisy-chain several ShowBoxes together off the same signal source(s) or add a subwoofer.

This output level is **NOT** affected by the main volume level and is post-channel fader and DSP, but pre-main fader. However, this output level **IS** affected by the main mute button!

It is wired as follows, according to standards specified by the AES (Audio Engineering Society):

### **Balanced XLR Output Connector:**

Pin 1 – Shield (ground)

Pin 2 – Positive (+ or hot)

Pin 3 – Negative (- or cold)

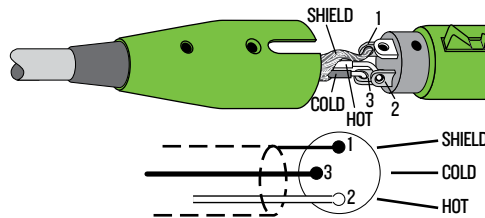

See page 39 to learn more about daisy-chaining ShowBoxes.

## USB-C Interface



This is a 2x2 interface that allows audio to stream to (and from) the ShowBox via smartphone or computer. This is the perfect tool to use when live streaming, including Facebook Live®, Instagram Live®, YouTube Live Streaming®, and Twitch®... or recording direct to computer for fun!

**USB Audio IN** – This connector allows the ability to transmit a **STEREO MIX OF ALL INPUTS TO** ShowBox from a connected computer or smartphone.

**USB Audio OUT** – This connector allows the ability to transmit a **STEREO MIX OF ALL INPUTS (including Bluetooth) FROM** ShowBox to a connected computer or smartphone.

This output level is **NOT** affected by the main volume level. Additionally, it is post-channel fader/DSP, but pre-main fader. Audio resolution is 24-bit / 48 kHz. This port also allows for future firmware updates to the ShowBox via connected PC.



If connected to computer, don't forget to change the input and output to 'ShowBox' via Settings.



If connected to a smartphone, don't forget to raise the volume of the device.



ShowBox's USB-C connection is audio only. It is not a source of power.



Directly to the right of the USB-C port is a very small hole. This hole is for conducting firmware updates via bent paperclip. Please download the firmware updating software from the product page to make sure you have the latest. Additionally, The RTC may be changed to your time zone by doing a firmware update. When a firmware update is completed, the RTC will sync with the time currently set on the computer that is connected to the ShowBox.

## Micro SD Port



Not only is the ShowBox a great amp/loudspeaker with some pretty amazing features, but here you can also record performances directly to a micro SD card! The micro SD slot is located to the right of the USB-C and remote jacks, below the PA mode button, and above the channel 3 XLR input. You can't miss it!

So what is recorded to a micro SD card? How about the whole enchilada?! We're talkin' a stereo mix of all inputs... including Bluetooth and FX sends! If a micro SD card is available – and plugged into the micro SD port – the SD Record LED on the breakaway mixer will illuminate green, indicating that it is ready for recording.

**Formatting** – We know you're an eager beaver, all psyched to start recording, but let's take care of something very important first: formatting the micro SD Card. First, get a micro SD Card; this could be a brand new one or one you've had for awhile so long as it's Class 10 or better.



micro SD Cards need to be Class 10 or better to ensure reliable operation. If using an older micro SD Card, it's a high possibility that some recordings will be dropped because the card is too slow. We are not in the business of suggesting what micro SD Card to go with, but choosing one with an instantly recognizable, quality, trustworthy name doesn't hurt.

Some examples we've heard of:

- SanDisk
- PNY
- Lexar
- Samsung
- Kingston



Once a micro SD card has been selected, PLEASE format it before using it!

There is much more information about micro SD recording on page 30.

## Front LED Button and LED



There are two horizontal LED bars located on the front grille of each ShowBox. They are centered, one on top and one on bottom. These LEDs illuminate green when the front LED button is engaged. Additionally, the switch's LED will illuminate green. Disengage the switch if you do not want the front panel LEDs to illuminate. We like to call this 'stealth' mode.

## Feedback Eliminator Button and LED



The multi-band feedback eliminator hunts down offending feedback frequencies and applies up to eight notch filters automatically to destroy feedback and maximize gain prior to feedback. This is a great tool for when an engineer is not present.

- **Off [Default]** – The feedback eliminator is not engaged. If filters have been applied, this setting will retain its current filter settings if there are any, but they will not be engaged until it is turned back on.
- **On** – When the automatic feedback eliminator is turned on, scanning occurs continuously. The eight filters will engage when feedback is present. If feedback is not identified, it will continue to look for (and replace) those bands. If feedback is identified on an existing filter, the notch will deepen to further destroy the offending feedback frequency. Pretty cool, huh?! The LED will illuminate green when engaged.

## Outdoor Mode Button and LED



Regarding outdoor mode... in a sentence, choose whether you are using ShowBox inside or outside. The speaker's voicing is altered to the environment. That's all you need to know, but we're going to give you more!

When speakers are outside, a combination of low and high frequencies don't build up the way they do inside. ShowBox corrects for that by boosting the frequency ranges that become deficient so the speaker sounds the same outside as when it's inside. You make the selection, we'll do the rest!

Additionally, when outdoor mode is engaged, the LEDs on the breakaway mixer are at full brightness, but are down to around 25-50% brightness when the outdoor mode switch is disengaged.

The outdoor mode LED will illuminate green when engaged (outdoors).

## PA Mode Button and LED



The ShowBox works as two kinds of "loudspeakers" with different built-in voicing modes:

**Amp (lifier) mode:** The default voicing – AMP MODE – is optimized as a busking instrument amplifier. The EQ curve focuses on clarity in the mid- and high-mid frequency ranges and is optimized around vocals and guitars. The LED will not be illuminated when in AMP MODE.

**PA mode:** PA MODE is optimized as a typical "loudspeaker". It is a great selection to choose for when live music has wrapped up and you simply want to play music through a "PA speaker". The EQ curve focuses on low frequency extension and resembles a slight smiley EQ curve (scooped mids). The LED will illuminate green when in PA MODE.

## Battery Charge Status LED



This single-colored LED indicates the charging status of the ShowBox battery. When the ShowBox is plugged into a live power outlet and the battery is charging, this LED will illuminate and slow flash green. When the battery is fully charged, this LED will illuminate solid green. When the ShowBox is not plugged into a live power outlet and/or the battery is not charging, this LED will not illuminate.

## Factory Reset

When a ShowBox is factory reset, it restores most parameters back to their default. This includes all EQ, FX, compressor parameters, and auto-connect, among others. **This is a permanent reset with no undo.**

So how does one place the ShowBox back to its factory default? With the ShowBox powered off, press and hold down the 'Front LED' and 'Feedback Elim' buttons. Keep holding them down and power up the ShowBox. After two seconds, release the buttons and the ShowBox settings are back to their factory default.



If you do a factory default reset, you are also wiping the ShowBox's memory of previously paired devices. To remedy this, on your phone, tablet or other Bluetooth device, you will need to 'forget device' in the Bluetooth settings, then re-pair in order to regain communication and functionality.

## Breakaway Mixer Data Port



This port sends and receives data to/from the breakaway mixer via the included CAT5 cable. This port is on the ShowBox. It will connect to the same data port on the breakaway mixer.

Additionally, the data port provides power to the USB-C connector on the rear panel of the breakaway mixer.

If the included CAT5 cable goes missing, gets chewed up by the cat and/or dog, and/or otherwise does not work, any major-brand CAT5 cable would make a fine replacement. Just make sure it's long enough to easily connect the ShowBox to the breakaway mixer.

## Battery Replacement

The Lithium-Ion Battery allows you to use ShowBox without the need to be plugged in or wasting money on expensive batteries. This is great for mobile gigging, live streaming, and more!



**SAFETY FIRST:** Before installing and using this product, please read these instructions carefully. Failure to follow the precautions may result in damage, injury, or even death.

- 1. WARNING:** The battery (battery or batteries or battery pack) shall not be exposed to excessive heat such as sunshine, fire or the like.
- 2. CAUTION:** Danger of explosion if battery is incorrectly replaced. Replace only with the same or equivalent type.
- 3.** No open flame sources, such as lighted candles, should be placed on the apparatus.

**WARNING:** When installing this product, always respect the safety standard. Do not install the product in any way that is not described in these instructions.

### **BATTERY / COVER REMOVAL INSTRUCTIONS:**

Unplug and power off the ShowBox and set it grille side down on a soft, flat surface.

Using a flathead or Phillips screwdriver, rotate the two locking tabs counter-clockwise. It should only be 1/4 to 1/2 a turn to unlock. Remove the battery compartment cover and set it aside.

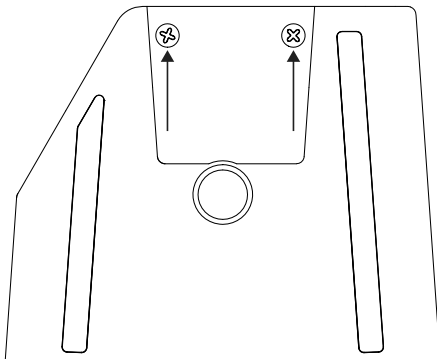



As seen below, the removable battery is surrounded by the dotted line.

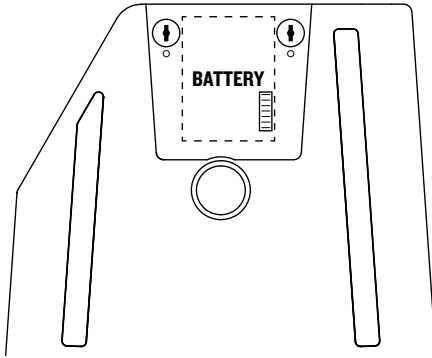

There are finger grips on each side of the battery, close to where the “battery” text is located. Remove the battery from captivity by lifting it straight out (towards you) to freedom.

**BATTERY INSTALLATION INSTRUCTIONS:**

Once the battery cover and battery have been removed and set aside, it’s time to insert a different one.



**NOTE:** Do not force the battery into place. There is only one way it fits and there should be no resistance during installation.

As seen in the drawing above, a vertical power connector is located in the lower-right corner from where the battery was removed. Line up the power connector of the battery with the power connector of ShowBox and press down/in. Again, this is an easy process; no force is necessary.

Replace the battery cover and lock it to the ShowBox by rotating the two locking tabs clockwise until they lock into place.



The battery will charge while inside a plugged-in ShowBox.

## Chapter 3 : ShowBox Breakaway Mixer

### Introduction

From top to bottom and left to right, each ShowBox Breakaway Mixer is outfitted with a bunch of knobs, buttons, jacks, LEDs, and more. So much more, in fact, that we will call out and describe each one... after a quick look at the top panel, we'll go to the rear panel features, then back to the top.

The Breakaway Mixer may either be docked with the ShowBox or removed and used as a wired controller (mounted onto a standard mic stand using the included mic stand mount clip, see page 35).



### Breakaway Mixer Data Port

This port sends and receives data to/from the breakaway mixer via the included CAT5 cable. This port is on the breakaway mixer. It will connect to the same data port on the ShowBox.

Additionally, the data port provides power to the USB-C connector on the rear panel of the breakaway mixer, as seen below-left.

If the included CAT5 cable goes missing, gets chewed up by the cat and/or dog, and/or otherwise does not work, any major-brand CAT5 cable would make a fine replacement. Just make sure it's long enough to easily connect the ShowBox to the breakaway mixer.



## USB-C Charging Thru Port

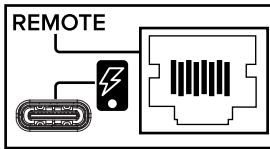

This handy hidden USB-C port simply has one purpose in life: to charge a smartphone or tablet. The plugged-in device can simply remain connected for a charge or use the device as the Bluetooth connection, or to scroll through sheet music and/or lyrics.

This port emits 2A when the ShowBox is plugged into a live power source and half that – 1A – when the ShowBox is running off of battery.

## CHANNEL select

### Channel Select Buttons



These channels align with the inputs on the rear panel of ShowBox. Pressing one of these buttons will select the corresponding channel for input-based editing. The LED centered on the button of the currently selected channel will illuminate green – channel 3 in the example above – and all others channels' LEDs will be off. All stored settings on that channel will be recalled when selected, including volume, EQ, compressor, FX, and more. Only one channel may be selected at a time. Thusly, only one channel's parameters may be updated at a time.

## CHANNEL control

### Channel Volume and Gain Knob

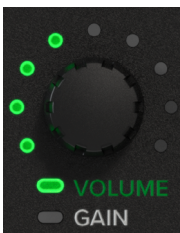

This push-button, rotatable knob has a massive amount of responsibilities, but lucky for us, it's up to the task! As you can see to the left, this knob sets the gain and volume levels, but did you know that it also mutes the selected channel? That there is an OL LED in addition to the level and gain LEDs? Did you know that ShowBox can properly set the gain using its auto-gain feature, too? Read about all that and more, starting with...

If you haven't already, please read the "Getting Started" section on page 7. Setting the gain correctly will ensure that the preamplifier's gain is not too high, where distortion could occur, and not too low, where the quieter, exquisitely-delicate passages might be lost in background noise. ShowBox is also blessed with an auto-gain feature that will set the gain automatically. We will begin by discussing gain, then moving on to volume. Read on...

The gain knob – in conjunction with the overload LED (the far-right LED) – adjust the input sensitivity of the mic and line inputs. This allows signals from the outside world to be adjusted to run through each channel at optimal internal operating levels.

By default, this knob is always on 'volume'. Gain is accessed by a single tap of the volume/gain knob. When tapped, the LEDs surrounding the volume/gain knob will turn from green to white. Additionally, the LED to the left of the 'gain' silkscreen will illuminate white, while the LED to the left of the 'volume' silkscreen will turn off. It will remain in gain mode so long as there is activity. It will revert back to volume mode after five seconds of inactivity (or another single tap of the volume/gain knob).

The default position for the gain knob is 1:00 o'clock (first six LEDs illuminated). The far-right – ninth – LED illuminates white (if at max gain). However, if the incoming signal is too hot, this LED will illuminate red to show that the input is clipping. If this occurs, turn down the gain.



Quickly double-tapping the volume/gain knob will mute the selected channel. The LEDs surrounding the volume/gain knob will flash when muted. [Green if double-tapped when volume is shown, white if double-tapped when gain is shown.]. The LED to the left of the volume silkscreen will illuminate solid red. Single- (or double-) tap the volume/gain knob to un-mute the channel.

Now that you are familiar with what gain is and how to access it, let's talk about a really cool feature on ShowBox: Auto-gain. That's right, ShowBox will set the gain automatically for inputs 1-5/6.

**SETTING AUTO-GAIN ON SHOWBOX:**

Here is how to set up auto-gain in seven easy steps:

1. Select the channel.
2. Press-and-hold the volume/gain knob down for two seconds in order to enter “auto-gain listening mode”.  
Note: this works whether the channel is in ‘volume’ mode or ‘gain’ mode.
3. The LED to the left of the ‘gain’ silkscreen will illuminate solid white and the LEDs surrounding the volume/gain knob will slow flash white. ShowBox is now awaiting your input... ten seconds, get on it!
4. ShowBox will listen to the input and determine the best gain setting for that input after 10 seconds has elapsed.



It may be difficult to do, but please try and keep your voice (and/or instrument) at the level you plan to sing/play. Otherwise, auto-gain may have a difficult time with a voice/instrument that raises and lowers often in a 10-second period!

5. The LEDs surrounding the volume/gain knob will display the position of the gain knob – in real-time – as the auto-gain is adjusted during the “listening” period.



The gain is unable to be adjusted manually during the “listening” period.

6. Once the gain has been decided on, the LEDs surrounding the volume/gain knob will quickly show the position before flashing all gain LEDs – first slowly, then quickly – before reverting back to volume mode and its green LEDs.
7. On the bottom of the breakaway mixer is a CliffsNotes® version of how to quickly set auto-gain... or you could always come back here and read the whole shebang!

As you might suspect...



Any manual adjustments to the gain will erase the set auto-gain and revert back to manual operation, and...  
...auto-gain listening mode may be accessed and overwritten at any time by holding down the knob for two seconds.

Have you had enough talk about gain? We sure have, so let’s move onto another favorite topic of ours... volume!

Volume is the last control in a channel’s signal path, and it adjusts the level of each channel onto the main mix. As mentioned earlier, by default, this knob is always on ‘volume’. The volume knob ranges from  $-\infty$  (OFF, knob far-left) to +10 dB of gain (MAX, knob far-right). Unity is at 12 o’clock (noon, first five LEDs illuminated).

The default position for the volume knob is 1:00 o’clock (first six LEDs illuminated). The far-right – ninth – LED illuminates green (if at max volume). However, if the incoming signal is too hot, this LED will illuminate red to show that the input is clipping. If this occurs, turn down the volume.



Quickly double-tapping the volume/gain knob will mute the selected channel. The LEDs surrounding the volume/gain knob will flash when muted. [Green if double-tapped when volume is shown, white if double-tapped when gain is shown.]. The LED to the left of the volume silkscreen will illuminate solid red. Single- (or double-) tap the volume/gain knob to un-mute the channel.

## Channel Equalization (EQ) Knobs

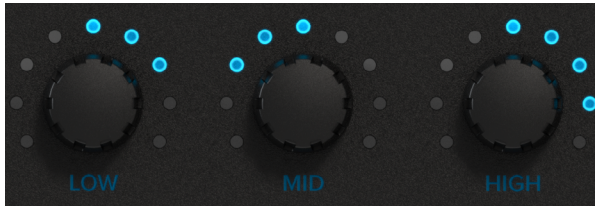

ShowBox has 3-band parametric EQ with shelving hi, peaking mid, and shelving low knobs. The 3-band equalization has low shelving at 80 Hz, mid peaking at 2.5 kHz, and high shelving at 12 kHz.

Shelving means that the circuitry boosts or cuts all frequencies past the specified frequency. For example, the low EQ boosts bass frequencies below 80 Hz and continuing down to the lowest note you never heard. Peaking means that certain frequencies form a “hill” around the center frequency.



With too much EQ, you can really upset things. We’ve designed a lot of boost and cut into each equalizer circuit because we know that everyone will occasionally need that. But if you max the EQ on every channel, you’ll get mix mush. Equalize subtly and use the left sides of the knobs (cut), as well as the right (boost). If you find yourself repeatedly using a lot of boost or cut, consider altering the sound source, such as placing a mic differently, trying a different kind of mic, a different vocalist, changing the strings, or gargling.

The EQ circuits are based upon the designs of Cal Perkins, an industry-leader in audio engineering for over four decades and a long-time collaborator. This “neo-classic” design provides the sweet musicality of the British EQ sound, while still maintaining 15 dB of boost and cut with optimum Q and minimum phase shift (in other words, it gives you plenty of control and is pleasing to the ear!).

### Hi EQ Knobs

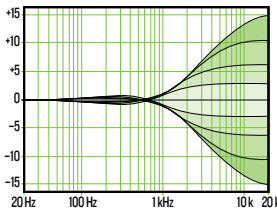

The hi EQ provides up to 15 dB of boost or cut above 12 kHz, and it is also flat (no boost or cut) at center (noon). Use it to add sizzle, an overall sense of transparency, or an edge to keyboards, vocals, guitar and bacon frying. Turn it down a little to reduce sibilance.

### Mid EQ Knobs

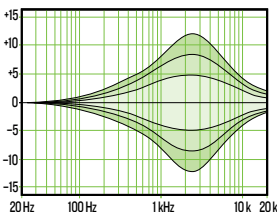

Short for “midrange,” this knob provides up to 15 dB of boost or cut, centered at 2.5 kHz, also flat at the center detent. Midrange EQ is often thought of as the most dynamic, because the frequencies that define any particular sound are almost always found in this range. You can create many interesting and useful EQ changes by turning this knob down as well as up.

### Low EQ Knobs

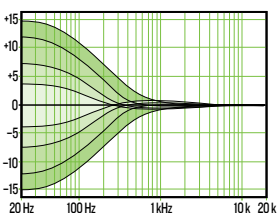

The low EQ provides up to 15 dB of boost or cut below 80 Hz. The circuit is flat at the center (noon). This frequency represents the punch in bass guitar, fat synth patches, and some really serious male singers who eat raw beef for breakfast.

Quickly double-tapping any of the EQ knobs allows for true bypass of the EQ circuitry to ensure that there is no coloration of the signal if the EQ is not needed. The LEDs surrounding the EQ knobs will flash when off. When the EQ is disengaged, the EQ controls have no effect on the signal. Use this to make an A/B comparison between the EQ'd signal and the signal without EQ. Single- (or double-) tap any EQ knob to turn the EQ back on.

Any number of input EQs may be bypassed simultaneously. Additionally, you can switch between channels, but the EQ will remain off (i.e. flashing LEDs) until an EQ knob on the selected channel is single- (or double-) tapped.

As you may have noticed on the previous page (or on an actual ShowBox), the single-color LEDs surrounding the EQ knobs are blue. The default position for all EQ knobs on all inputs is 12 o'clock (noon, top-centered LED illuminated).

### Compressor Knob



Channels 1–4 of each ShowBox has an in-line compressor circuit with a variable threshold.



This is very useful for compression of vocals, for example.

When the incoming signal exceeds the threshold level set by this knob, the signal level is automatically compressed. This reduces the dynamic range and reduces the chance of distortion due to overloading the input signals.



Dynamic range is the difference in level between the quietest and loudest parts of a song. A compressor “squeezes” the dynamic range, resulting in an overall steadier, more constant volume level for the signal. It helps sources, such as vocals, “sit” properly in the mix; it is very useful for live sound.

As the compressor amount knob changes, it will scale both the threshold and the makeup gain. The scaling goes from 0 at fully counter-clockwise to 1.0 at fully clockwise. That scaling value will be applied to both the threshold and the makeup gain. For example, say the compressor is set up with a threshold of  $-30$  dB and a makeup gain of  $+10$  dB. Here is a table of what the threshold and makeup gains would look like at different amount settings:

	Amount	Threshold	Makeup Gain
	0 (Fully Counter-Clockwise)	$-30 \text{ dB} * 0 = 0 \text{ dB}$	$+10 \text{ dB} * 0 = 0 \text{ dB}$
	0.25	$-30 \text{ dB} * 0.25 = -7.5 \text{ dB}$	$+10 \text{ dB} * 0.25 = 2.5 \text{ dB}$
	0.5 (Mid, Noon)	$-30 \text{ dB} * 0.5 = -15 \text{ dB}$	$+10 \text{ dB} * 0.5 = 5 \text{ dB}$
	0.75	$-30 \text{ dB} * 0.75 = -22.5 \text{ dB}$	$+10 \text{ dB} * 0.75 = 7.5 \text{ dB}$
	1.0 (Fully Clockwise)	$-30 \text{ dB} * 1.0 = -30 \text{ dB}$	$+10 \text{ dB} * 1.0 = 10 \text{ dB}$

Outboard compressors often have controls such as compression ratio, soft knee/hard knee, attack time, and release time. These last two affect how quickly the compressor kicks in when the input exceeds the threshold, and how quickly it is released after it drops below the threshold. In this compressor, these parameters are specially chosen to give you the best overall performance.

Adjust the threshold carefully, so your dynamic range is still lovely, without distortion or overload during the performance. Run through a few practice screams and high-notes, and adjust the compression as required.

Quickly double-tapping the compressor knob allows for true bypass of the compressor circuitry to ensure that there is no coloration of the signal if the compressor is not needed. The LEDs surrounding the compressor knob will flash when off. When the compressor is disengaged, the compressor control has no effect on the signal. Use this to make an A/B comparison between the comp'd signal and the signal without compressor. Single- (or double-) tap the compressor knob to turn the compressor back on.

Any number of input compressors may be bypassed simultaneously. Additionally, you can switch between channels, but the compressor will remain off (i.e. flashing LEDs) until the compressor knob on the selected channel is single- (or double-) tapped.

As you may have noticed on the previous page (or on an actual ShowBox), the single-color LEDs surrounding the compressor knob is white. The default position for the compressor knob on all inputs is off (far-left LED illuminated).



The compression is post-preamp but pre-EQ.

## Presence Knob



Many guitar amplifiers have a presence knob and ShowBox is no different. But that's where the similarities end... and frankly, we think ours is superior, anyway. ShowBox is dedicated to not only delivering a premium sound, but a superior look (and the charisma) to go along with it. That's right, this knob gives you STAGE presence!

Stage presence is the mix of your outfit and onstage charisma... and we're here to help! If you recall what Colorforms® are, this works (somewhat) similarly. In short, Colorforms® are vinyl cutouts that can easily be added to – and removed from – smooth surfaces. This, though, is YOUR chosen outfit.

### **SELECTING PRESENCE ON SHOWBOX:**

Here is how to set up stage presence in five easy steps:

1. Select the channel.
2. Single-tap the presence knob to enter 'Presence Select Mode'. The LEDs surrounding the FX knob will illuminate and flash red when tapped. Additionally, the scribble strip will also flash at the same rate.
3. When flashing, rotate the endless knob to find and select a decade. Once found, press the button to make the selection. It will replace the previously selected decade on the scribble strip. It will remain in 'Presence Select Mode' so long as there is activity. It will revert back to normal (solid LEDs) after ten seconds of inactivity (or another single tap of the presence knob).
4. Once an effect is selected – regardless of choice and channel – the presence amount is set to the default position of 12 o'clock (noon, first five LEDs illuminated).
5. Rotate the endless knob to scroll through all of the different available outfits, hairstyles, and more, from that decade. After five seconds of inactivity, look down at yourself. The outfit has changed! Now take a look in the mirror. How about that hair and makeup?! Looking sharp!



Be aware that selecting "None" will render you completely naked! It is an option for our "free spirits" out there, but please be aware of your local laws regarding indecent exposure.

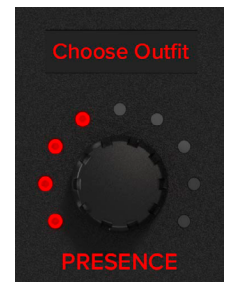

## FX Knobs



These two push-button, rotatable knobs have a massive amount of responsibilities, but lucky for us, they're up to the task! As you can see to the left, the knob on the left is where to select FX1 and access the tuner, and the knob on the right is where to select FX2 and access snapshots. But there is more... so, so, so much more! Read all about it, starting below...

We will begin by discussing the FX1 / tuner knob, then moving on to the FX2 / snapshots knob. By default, no effects are selected – “None” written on the scribble strips above each FX knob – and not available (“N/A”) on channel 5/6.

### SELECTING FX ON SHOWBOX:

Here is how to select FX in five easy steps [FX1 and FX2]:

1. Select the channel.
2. Single-tap the FX1 or FX2 knob to enter 'FX Select Mode'. The LEDs surrounding the FX knob will illuminate and flash yellow when tapped. Additionally, the scribble strip will also flash at the same rate.
3. When flashing, rotate the knob to find an effect. Once found, press the button to make the selection. It will replace the previously selected effect on the scribble strip. It will remain in 'FX Select Mode' so long as there is activity. It will revert back to normal (solid LEDs) after ten seconds of inactivity (or another single tap of the FX knob).
4. Once an effect is selected – regardless of choice and channel – the FX amount is set to the default position of 12 o'clock (noon, first five LEDs illuminated).
5. Rotate the knob to increase/decrease the amount of effect for the selected channel. The FX knobs range from OFF (knob far-left) to MAX (knob far-right). Unity is at 12 o'clock (noon, first five LEDs illuminated).

FX1 Number	FX1 Effect
0	NONE
1	SMALL CHORUS
2	LARGE CHORUS
3	FAST DELAY
4	SLOW DELAY
5	DELAY + CHORUS
**6	**REVERSE DELAY
7	OVERDRIVE
8	FUZZ
9	CRUNCH
10	FLANGER
11	PHASER
12	TUBE MODEL
**13	** ACOUSTIC GUITAR SIM
14	TREMOLO

\*\*These FX are available only on channels 2 and 4.

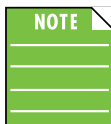

Quickly double-tapping an FX knob allows for true bypass of the effect to ensure that there is no coloration of the signal if the effect is not needed. The LEDs surrounding the FX knob will flash when off. However, the scribble strip LEDs will remain solid. When the effect is disengaged, the FX control has no effect on the signal. Use this to make an A/B comparison between the FX'd signal and the signal without effect. Single- (or double-) tap the FX knob to turn the effect back on.

**FX1** – By default, the left knob is always on 'FX1' (not tuner).



The effects on FX1 are in series (i.e. inline effects). This means that channels 1-4 can each have a different effect without sharing... (unless you want to)! The following helps us remember the differences, and perhaps it will help you, as well:

FX1 = Series = Separated  
 FX2 = Parallel = Paired

Keep in mind that the FX level may be set differently for all four channels.

There are additional details about the FX in Appendix C (pages 47-48).



**Tuner** – When the FX1/Tuner knob is pressed (and held) for two seconds, the channel is muted and the tuner is activated. The majority of the time, the LED to the left of the FX1 silkscreen will illuminate solid yellow, but when the tuner is accessed, it will illuminate and the FX1 LED will go dark. The scribble strip will display the note that is currently being played. Additionally, while the note is played, the LEDs surrounding the knob give out important details. If it's at 12 o'clock (noon), the note is perfectly in tune, huzzah! Any illuminated LEDs to the left are flat notes, and, yep, you guessed it... any illuminated LEDs to the right are sharp notes. It will revert back to normal FX mode after ten seconds of inactivity (or a single tap of the FX knob).

**FX2** – The previous page has step-by-step instructions on how to select FX on ShowBox.

By default, the right knob is always on 'FX2' (not snapshot).



The effects on FX2 are in parallel (i.e. time-based effects). This means that shared channels also share effects. The shared channels in this case are the XLR inputs (channels 1 + 3) and the 1/4" instrument inputs (channels 2 + 4). Unfortunately, ShowBox does not have the processing power to allow FX2 to be run in series due to the memory-hogging effects available on FX2. The following helps us remember the differences, and perhaps it will help you, as well:

FX1 = Series = Separated

FX2 = Parallel = Paired

Keep in mind that the FX level may be set differently for all four channels.

There are additional details about the FX in Appendix C (pages 47-48).

FX2 Number	FX2 Effect
0	NONE
1	SMALL PLATE
2	LARGE PLATE
3	SMALL ROOM
4	LARGE ROOM
5	SMALL HALL
6	LARGE HALL
7	SPRING REVERB
8	SMALL CHORUS
9	LARGE CHORUS
10	FAST DELAY
11	SLOW DELAY
12	DELAY + REVERB
13	DELAY + CHORUS
**14	**REVERSE DELAY
15	FLANGER
16	PHASER
17	TREMOLO
**These FX are available only on channels 2 and 4.	

**Snapshots** – The snapshots section allows you to save up to five settings to memory that may be recalled at a later time. This is a great option for a rotating cast of musicians, different venues, or a guitarist that HAS to have several settings. We've got your back! We think going through steps may be easier here, rather than trying to find where it exists among all of these other words.

**ACCESSING SNAPSHOTS ON SHOWBOX:**

Here is how to access snapshots in nine easy steps:

1. Select channel 1-4.
2. Press-and-hold the FX2/Snapshots knob down for two seconds in order to enter "snapshots mode".  
Note 1: The effects will be muted.  
Note 2: The majority of the time, the LED to the left of the FX2 silkscreen will illuminate solid yellow, but when the snapshots are accessed, it will illuminate and the FX2 LED will go dark.
3. Does the breakaway mixer look like it's been broken with all those flashing LEDs? Do not fret, this is normal! The scribble strip will flash between displaying "None" and "Snapshot 1".
4. From here, you are able to rotate the knob clockwise to view snapshots 2-5, as well as "Default" and "Back".  
Note: It will revert back to normal FX mode after ten seconds of inactivity... (or scroll all the way to the end, where "Back" is selected, then single tap the FX knob to return).
5. Once a choice has been made, push the knob in to make the selection.
6. If snapshot 1-5 is the chosen one, then the scribble strip will display the following text:  
**Save** – Select this to save the current settings to the corresponding snapshot.



**Please be aware that the new settings will replace the currently saved settings.**

- Recall** – Select this to recall the settings of the corresponding snapshot.
- BK** – Select this to return to the main snapshots mode, step 4 above.

Rotate the knob until the selection you want is highlighted [i.e. boxed in] and push to confirm the choice. Once selected, it will revert back to normal FX mode (solid LEDs).

7. In step 4 above, we mentioned that one of the choices was "Default".  
If "Default" is the chosen one, then the scribble strip will display the following text:  
**Recall** – Select this to recall the settings to their factory default.  
**BK** – Select this to return to the main snapshots mode, step 4 above.

Rotate the knob until the selection you want is highlighted [i.e. boxed in] and push to confirm the choice. Once selected, it will revert back to normal FX mode (solid LEDs).

8. Slowly scroll through the five snapshots. Notice that the LEDs will display the stored snapshot settings of the selected channel. However, you are able to switch between other channels to view their settings before selecting, as well. Cool!
9. On the bottom of the breakaway mixer is a CliffsNotes® version of how to quickly access snapshots... or you could always come back here and read the whole shebang!

**External FX Loop Knob**

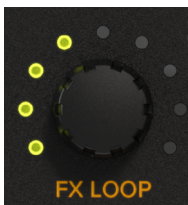

The external FX loop knob adjusts the "wet" level of each channel coming back from the external return. The external FX loop knob ranges from OFF (knob far-left) to MAX (knob far-right). Unity is at 12 o'clock (noon, first five LEDs illuminated). The default position for the FX loop knob is OFF (7:00 o'clock, first LED illuminated). Read more about the 1/4" external FX send and return jacks on page 11.



Quickly double-tapping the external FX loop knob will mute the external FX on the selected channel. The LEDs surrounding the external FX loop knob will flash when muted. Single- (or double-) tap the external FX loop knob to un-mute the external FX.

## LOOP control

### Looper Button



Oh, loopers are glorious, aren't they?! If you happen to be unfamiliar with what loopers are and what they do, they record and playback music (in real-time). Sometimes they're external pedals, sometimes they're built into amps, and sometimes they're in rackmount effects. Lucky for you, a looper was built in to the ShowBox circuitry!

At its default, the looper button is not engaged and the LED will remain unlit.

### WORKING THE LOOPER ON SHOWBOX:

Here is how to work the looper in four easy steps:



In most of these cases, we have seen that that a channel needs to be selected first. That is not the case with the looper. Any number of channel(s) may be looped simultaneously, regardless of what channel is selected.

1. Single-tap the looper button to engage the first recording loop.  
The button's LED will illuminate and slow flashes white when tapped.  
**Note:** ShowBox can record/loop up to a total of four minutes of mono record time at 48 kHz.
2. Single-tap the looper button again to stop recording the first loop. The button's LED will stop flashing and instead illuminate solid white. Additionally, it will immediately begin playback.
3. There are a multitude of choices you can make from here, including...
  - 3a: Doing nothing. Just continue playing, you only needed one loop, everything in its right place.
  - 3b: Adding additional loop(s). Simply follow steps 1 and 2 above for however many more loops you want to record.  
It will keep (and play) the recorded loop(s) and overdub the new loop on top of it.  
Keep in mind that when the LED is flashing, it is recording, when it is solid, it is on playback.
  - 3c: Stopping the loop. Regardless of the number of loops recorded, double-tap the looper button to stop the loop.  
The button's LED will illuminate solid red.  
**Note 1:** Single-tap the looper button again to start playback. Double-tapping here simply continues the stop.  
**Note 2:** When disengaged, it will start at the beginning of the loop, not from where it was stopped.
  - 3d: Clearing the loop. Did ya eat it on the loop? Fingers got all sweaty? Voice started cracking? Don't sweat it, we've all been there. Let's start fresh with a clean slate by clearing the loop. Tap-and-hold the button down for two seconds to erase any memory of those awful recordings. The button's LED will no longer illuminate, indicating that the loop has been cleared.  
"That was a great take, but let's do another one." Head back to step 1.
4. On the front of the breakaway mixer – just above the looper button (also seen in the picture above) – is a CliffsNotes® version of how to work the loop: top line = single tap (rec/play/overdub), middle line = double-tap (stop playback), the last in line = tap-and-hold (clear loop)... or you could always come back here and read the whole shebang!

Now let's play a game of 10 questions!

**Q1: Can I change the FX?**

**A1:** Starting off with a trick question, I like it! The answer is both "yes" and "no". Yes, you can change the FX and make another loop with the newly selected FX. However, if you have already recorded loops with certain FX, you cannot change them after the fact, gotta record those again.

**Q2: How about the gain/volume, EQ, comp, etc... can I change those?**

**A2:** The answer is the same as above. Feel free to change everything to your heart's content and add as many loops with as many different settings as you want. Again, though, recorded loops are already recorded and cannot be updated after the fact.

**Q3: Can loops be recorded to an SD card or computer?**

**A3:** Yes! Read more about SD recording on pages 30, and computer recording on page 13.

**Q4: Can loops be saved to a snapshot?**

**A4:** No. Snapshots are already saving a ton of information, but it cannot handle files of that size, unfortunately.

**Q5: What is the maximum number of loops can I make? When does the ShowBox Looptender cut me off?**

**A5:** Two questions receive two answers. Max number = unlimited. That's right, the ShowBox Looptender will never cut you off! In reality, it's not "never". Reality is something that we have never reached. Challenge accepted...?

**Q6: Can a footswitch be used to toggle between looper modes?**

**A6:** Absolutely! It is the left button on a two-button footswitch.

**Q7: There has got to be a Looper Blooper Reel. Where can I find it?**

**A7:** Ha, you wish! Of course there's a Looper Blooper Reel. Share with you? Never!

**Q8: What happens if my first x number of loops were caught perfectly, but I ate it on the next loop?**

**A8:** Ooooh, say it ain't so. Unfortunately, you have to start from the beginning. Yeah, it's happened to us a few times, as well.

**Q9: When a ShowBox is power-cycled – turned off, then back on – will the loops still be there?**

**A9:** No!

**Q10: Ok, I've tried everything and I can't even hear the loops. What's up with that?**

**A10:** To the left of the looper button is a loop level knob (see below). If that knob is to the far-left, you won't hear anything. You have to rotate it clockwise in order to turn up the loop level to a satisfactory volume.

### Loop Level Knob



The loop level knob acts (somewhat) like another input volume knob... but the input in this case is whatever has been recorded to the looper. Rotate this knob clockwise to turn the volume of the loop level up, and rotate it counter-clockwise to turn the volume of the loop level down.

This is often confused with the loom level knob which is used for weaving. The loom level knob is accessed by a single-tap of the loop level knob. Then rotate the knob to raise or lower the level of the loom.

## MAIN control

### Main Volume Knob and Mute Button



The main volume knob adjusts the overall signal level at the input to the built-in power amplifiers. The main mix signals ranges from off ( $-\infty$ ) with the knob fully down, unity gain is at 12 o'clock (noon, top-centered LED illuminated), and fully up (max) provides +6 dB of additional gain. This additional gain will typically never be needed, but it's nice to know that it's there.

As you may have noticed to the left (or on an actual ShowBox), the single-color LEDs surrounding the main volume knob are green. The default position for the main volume knob is 12 o'clock (noon, top-centered LED illuminated).

The far-right – ninth – LED illuminates green (if at max volume). However, if the incoming signal is too hot, this LED will illuminate red to show that the input is clipping. If this occurs, turn down the input volume/gain knob and/or main volume knob.



Quickly double-tapping the main volume knob will display the firmware version of the ShowBox ("base", replacing the FX1 scribble strip) and the breakaway mixer ("UI", replacing the FX2 scribble strip). The FX will be displayed again after 4-5 seconds. Now that you know how to view the firmware versions, here's a friendly reminder that you should let the knob remain peaceful, calm and tranquil, only viewing the firmware versions if instructed by Tech Support. Thank you for listening!



Located conveniently below the main volume knob is the main mute button. Pressing it mutes all inputs... including the phones output and mix output. Additionally, the button's LED will illuminate red to confirm the mute. If there is no sound coming out, be sure to check this switch first. If you desire phones output only, turn the main volume knob all the way off, and make sure the headphone volume is up. We all have family, friends, and roommates that don't want to be bothered by our songs, either.

### Headphones Volume Knob

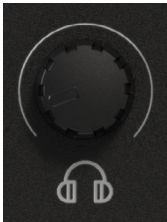

This knob is used to adjust the volume at the phones output from  $\infty$  (off) to maximum gain (max). Make sure that this knob is fully off before selecting or adding a new source.



**WARNING:** The headphone amp is loud and can cause permanent hearing damage. Even intermediate levels may be painfully loud with some headphones. **BE CAREFUL!** Always turn the phones level control all the way down before connecting headphones, or doing anything new that may affect the headphone volume. Then turn it up slowly as you listen carefully.

## Micro SD Button and LED



ShowBox allows your masterpieces to be recorded live to micro SD card! When the micro SD port is empty – no card inserted – the SD record button LED remains off. But when a (formatted) micro SD card is inserted into the port, the SD record button LED will illuminate solid green.

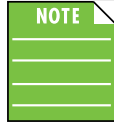

If the micro SD card has not been formatted – or has been improperly formatted – the SD record button LED will illuminate and quick-flash green. This LED will also quick-flash green when the storage of the micro SD card is full. No more recordings may be made on this micro SD card until space has been made (i.e. recordings deleted).

### **RECORDING TO MICRO SD CARD ON SHOWBOX:**

Here is how to record to micro SD card in four easy steps:



In most of these cases, we have seen that that a channel needs to be selected first. That is not the case with micro SD card recording. All channels will be recorded, regardless of what channel is selected.

1. Single-tap the SD record button to begin recording.  
The button's LED will illuminate and slow flash green when tapped.
2. Single-tap the SD record button again to stop recording.  
The button's LED will stop flashing and instead illuminate solid green once again.  
Note: The saved recording is in stereo WAV format at a resolution of 24-bit / 48 kHz.
3. Repeat steps 1 and 2 for each recording you want to make.  
You may make as many recordings as desired... until the micro SD card runs out of storage.
4. On the bottom of the breakaway mixer – and above the SD record button – is a CliffsNotes® version of how to record to SD card... or you could always come back here and read the whole shebang!

A few notes about recording to micro SD card:

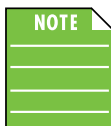

The naming convention of the recorded files begins with “REC\_001.WAV” and ascends with each new recording thereafter (i.e. “REC\_002.WAV”, “REC\_003.WAV” and so forth). That said, feel free to rename the recordings something that may be a little easier to recall.



Please read the note above first. If recorded file names – “REC\_xxx.WAV” – have been renamed (and/or deleted), the naming convention will still remain the same once the micro SD card has been reinserted into the ShowBox micro SD slot, but no recordings will ever be recorded over. It will just save as the next “REC\_xxx.WAV” in the naming convention. For example, if the first three recordings have been deleted, yet “REC\_004.WAV” remains, ShowBox will save the new recordings as “REC\_001.WAV”, “REC\_002.WAV”, “REC\_003.WAV”, “REC\_005.WAV”, “REC\_006.WAV”, etc. (skipping “REC\_004.WAV”) since it still exists.

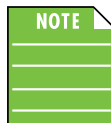

The recorded WAV files include a time stamp of the date and current time set by the internal RTC. Main headquarters is located in Bothell, WA (USA), therefore the factory default is set to Pacific Time. The RTC may be changed to your time zone by doing a firmware update. When a firmware update is completed, the RTC will sync with the time currently set on the computer that is connected to the ShowBox.

### Battery Level Indicator LED



The battery indicator LED on the breakaway mixer reflects the status of the battery located inside of the ShowBox. The battery level information is sent from the ShowBox to the LED located in the upper-right corner of the breakaway mixer.

The LED behaves as follows:

Green = 20%-100% battery remaining

Yellow = 5%-20% battery remaining

Red = 5% or less battery remaining

Off = No battery detected

Flashing Red = The breakaway mixer is not receiving enough power (<+10V) and cannot function.

All other LEDs on the breakaway mixer will also be off.

## Chapter 4 : Protection Circuitry

---

### Introduction

ShowBox employs a built-in limiter for less distortion at peak levels. A dynamic bass response circuit provides optimal low frequency response regardless of overall output level. Additional protection includes automatic thermal shutdown should the amp overheat. However, with Class-D amp technology, which is highly-efficient, this should never be a problem.



The protection circuits are designed to protect it under reasonable and sensible conditions. Should you choose to ignore the warning signs [e.g. excessive distortion], you can still damage the woofer in the loudspeaker by overdriving it past the point of amplifier clipping. Such damage is beyond the scope of the warranty.

### Limiting

Let's take a peek under the hood at the polymer compression driver. Compared to other available drivers, these provide a substantially smoother high-frequency response which results in a studio monitor level of accuracy and clarity. Furthermore, these drivers offer an insanely smooth transient response behavior. Yes, we, too, are fans of our own products!

Continuing on, the driver has its own compression circuit which helps protect it from damaging transient peaks. The compressor is designed to be transparent and is not noticeable under normal operating conditions.

### Overexcursion Protection

A subsonic filter circuit just prior to the power amplifier prevents ultra-low frequencies from being amplified. Excessive low-frequency energy can damage the woofer by causing it to “bottom out,” also known as overexcursion, which is equivalent to a mechanical form of clipping.

### Thermal Protection

All amplifiers produce heat. ShowBox is designed to be efficient both electrically and thermally. In the unlikely event of the amplifier overheating, a built-in thermal switch will activate, muting the signal.

When the amplifier has cooled down to a safe operating temperature, the thermal switch resets itself, and the ShowBox resumes normal operation.

If the thermal switch activates, try turning down the level control(s) a notch or two (or via the main volume knob) to avoid overheating the amplifier. Be aware that direct sunlight and/or hot stage lights may be the culprit of an amplifier overheating.



## AC Power

Be sure the ShowBox is plugged into an outlet that is able to supply the correct voltage. It will continue to operate at lower voltages, but will not reach full power. Be sure the electrical service can supply enough amperage for all the components connected to it.

We recommend that a stiff (robust) supply of AC power be used because the amplifiers place high current demands on the AC line. The more power that is available on the line, the louder the speaker will play and the more peak output power will be available for a cleaner, punchier bass. A suspected problem of “poor bass performance” is often caused by a weak AC supply to the amplifiers.



Never remove the ground pin on the power cord or any other component of the ShowBox. This is very dangerous.

## Care and Maintenance

Your ShowBox will provide many years of reliable service if you follow these guidelines:

- Avoid exposing it to moisture. If it is set up outdoors, be sure it is under cover if rain is expected.
- Avoid exposure to extreme cold (below freezing temperatures). If you must operate in a cold environment, warm up the voice coils slowly by sending a low-level signal through them for about 15 minutes prior to high-power operation.
- Use a dry cloth to clean the cabinet. Only do this when the power is turned off. Avoid getting moisture into any of the openings of the cabinet, particularly where the drivers are located.

## Chapter 5 : Placement

### Introduction



**WARNING:** Installation should only be done by an experienced technician. Improper installation may result in damage to the equipment, injury or – while highly unlikely – death. Make sure that the ShowBox is installed in a stable and secure way in order to avoid any conditions that may be dangerous for persons or structures.

ShowBox is designed to sit on the floor or stage as the main PA or as monitors. They may also be pole-mounted via the built-in socket on the bottom of the cabinet. Be sure the pole is capable of supporting the weight of the ShowBox. The T100 is a great tripod option and the SPM200 (unthreaded) or SPM400 (threaded) is a nice choice when using a subwoofer.



ShowBox does not have any fly points and may NOT be flown. NEVER attempt to suspend a ShowBox by its handles.

Check to make sure that the support surface (e.g. floor, etc.) has the necessary mechanical characteristics to support the weight of the ShowBox.

When pole-mounting ShowBox, be sure that they are stabilized and secured from falling over or being accidentally pushed over. Failure to follow these precautions may result in damage to the equipment, personal injury, or death.

ShowBox may also be laid out horizontally as a monitor at a 45° angle (as seen below). It is intended to be used only when the speaker is in its wedge configuration and works best when on a hard work surface, like a stage.

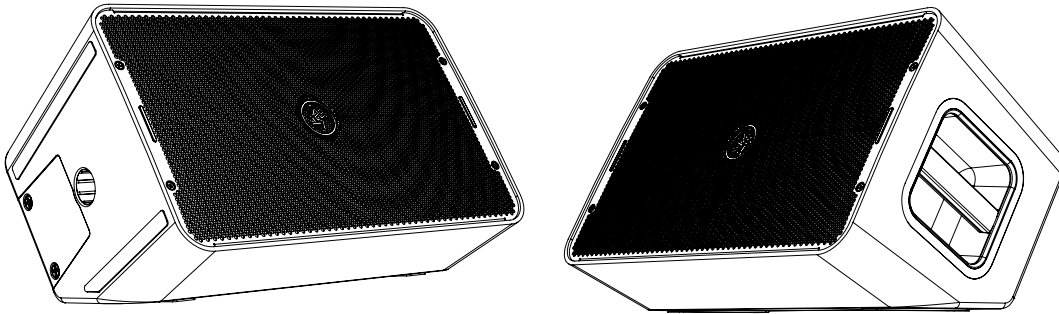

As seen above, the Running Man logo is rotatable for when ShowBox is used as a monitor!

As with any powered components, protect them from moisture. Avoid installing ShowBox in places exposed to harsh weather conditions. If you are setting them up outdoors, make sure they are under cover if you expect rain.

## Connecting the Breakaway Mixer to a Mic Stand

Connecting the Breakaway Mixer to a mic stand is an easy two-step process.

1. Attach the included mount (for the breakaway mixer) to the mic stand. It only fits one way. Once positioned, tighten the mount to the mic stand by rotating the adjustment knob clockwise; rotate it counter-clockwise to loosen.
2. Line up the notches between the breakaway mixer and the mount and drop it in to connect.

See below for a visual representation. Now you're ready to play some shows!

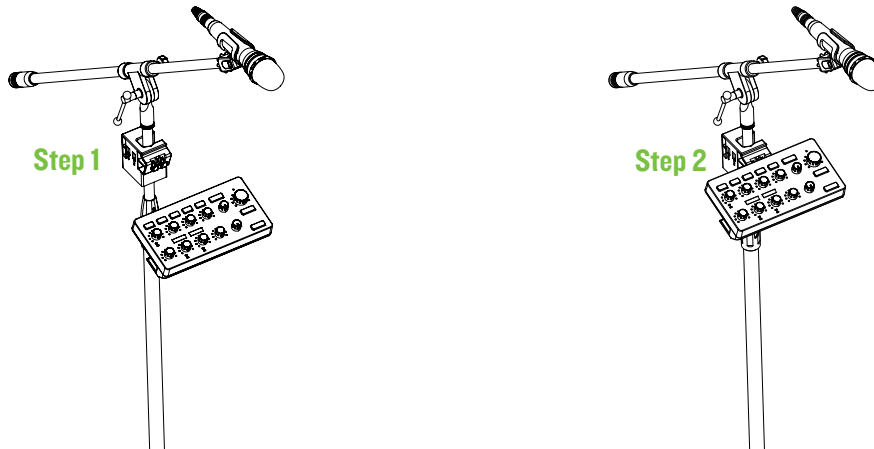

## Room Acoustics

ShowBox is designed to sound fantastic in nearly every application.

But, room acoustics play a crucial role in the overall performance of a sound system. However, the wide high-frequency dispersion of ShowBox helps to minimize the problems that typically arise.

Here are some additional placement tips to help overcome some typical room problems that might arise:

- Placing ShowBox in the corner of a room increases the low frequency output and can cause the sound to be muddy and indistinct.
- Placing ShowBox against a wall increases the low frequency output, though not as much as corner placement. However, this is a good way to reinforce the low frequencies, if so desired.
- Avoid placing ShowBox directly on a hollow stage floor. A hollow stage can resonate at certain frequencies, causing peaks and dips in the frequency response of the room. It is better to place it on a sturdy stand designed to handle the weight of the ShowBox.
- Position the ShowBox so the high-frequency driver is two to four feet above ear level for the audience (making allowances for an audience that may be standing/dancing in the aisles). High frequencies are highly directional and tend to be absorbed much easier than lower frequencies. By providing direct line-of-sight from the ShowBox to the audience, you increase the overall brightness and intelligibility of the sound system.
- Highly reverberant rooms, like many gymnasiums and auditoriums, are a nightmare for sound system intelligibility. Multiple reflections off the hard walls, ceiling, and floor play havoc with the sound. Depending on the situation, you may be able to take some steps to minimize the reflections, such as putting carpeting on the floors, closing draperies to cover large glass windows, or hanging tapestries or other materials on the walls to absorb some of the sound.

The best approach is to provide as much direct sound coverage to the audience as possible. The farther away you are from the speaker, the more prominent will be the reflected sound. Keep in mind that the feedback eliminator (page 14), indoor/outdoor mode (page 15), and amplifier/PA mode (page 15) are other great ways to compensate for some of these issues. The correct gain (pages 19-20), I/O volume (pages 19-20, 29), and EQ settings (pages 21-22) also play a crucial role.

## Hookup Diagrams

### Hookup Diagrams > Singer-Songwriter / Busker

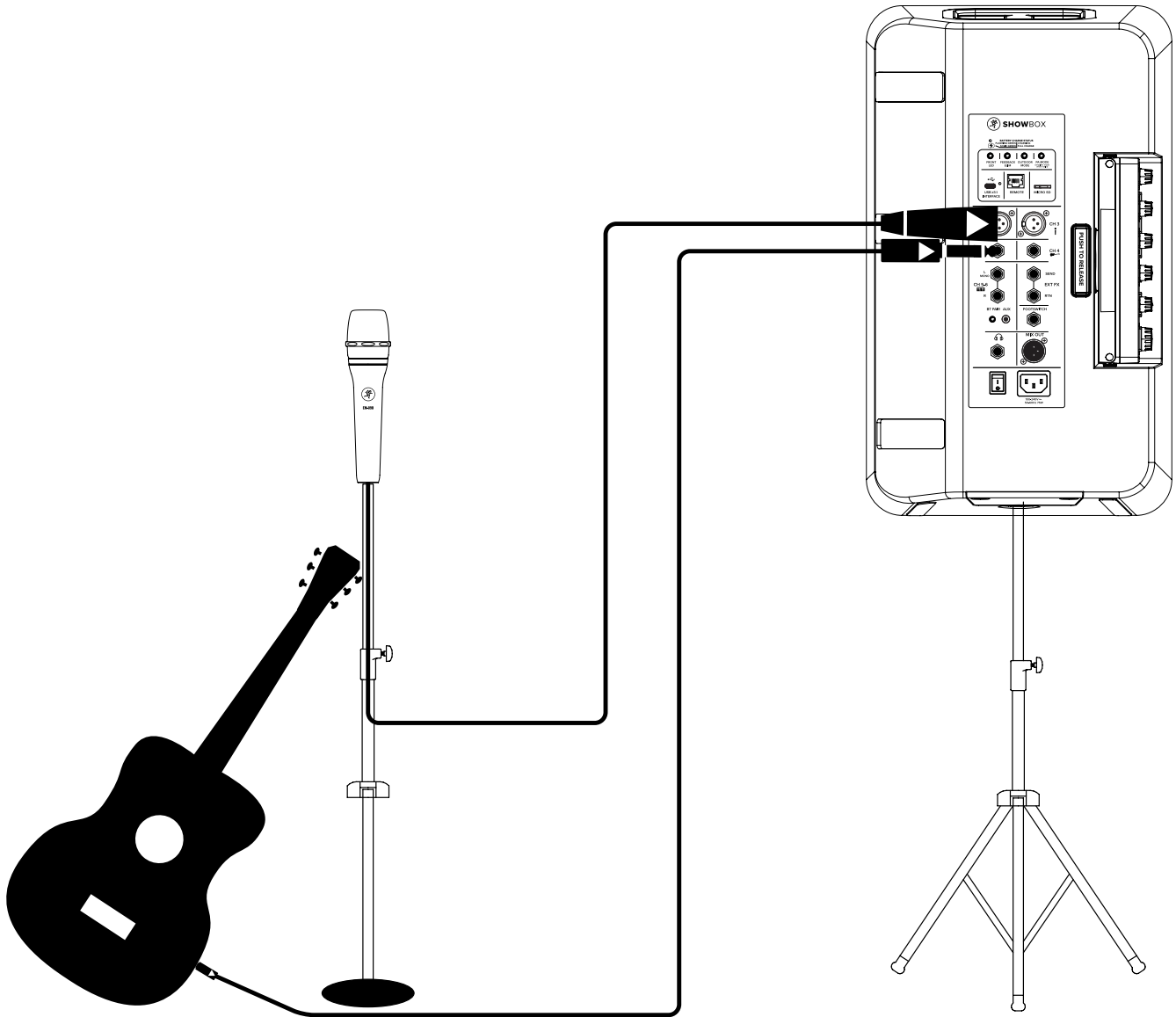

ShowBox is a great tool for singer-songwriters, buskers, full bands, karaoke enthusiasts, and much more!

In this example, our busking hero connects their trusty Mackie EM-89D dynamic microphone into the channel 1 XLR input and guitar into the channel 2 input. From here, set up the channel 1 and 2 inputs as you see fit. This includes the gain/volume levels, EQ settings, compressor level, FX (1 and 2), and more! If you have a 2-button footswitch, connect it to the footswitch jack in order to turn FX on and off, as well as add loops. If you don't have a footswitch, order the Mackie one (PN 2056472)!

As seen in the previous pages, there are a multitude of other features that may be utilized in all three of these hookup diagrams. For example, the performance may be livestreamed via the USB-C connection and/or recorded directly to micro SD card. A subwoofer (or additional ShowBox) may be connected to the mix out jack. Are guitar pedals being added to the mix? If so, they can be routed via the external FX send and return jacks. A phone or tablet can be connected to ShowBox via Bluetooth for playback [i.e. put it in PA mode and play tunes through it while setting up (and tearing down) equipment].

...and lest we forget, before beginning the performance, be sure to utilize the ShowBox's tuner feature!

Hookup Diagrams > Karaoke Enthusiasts

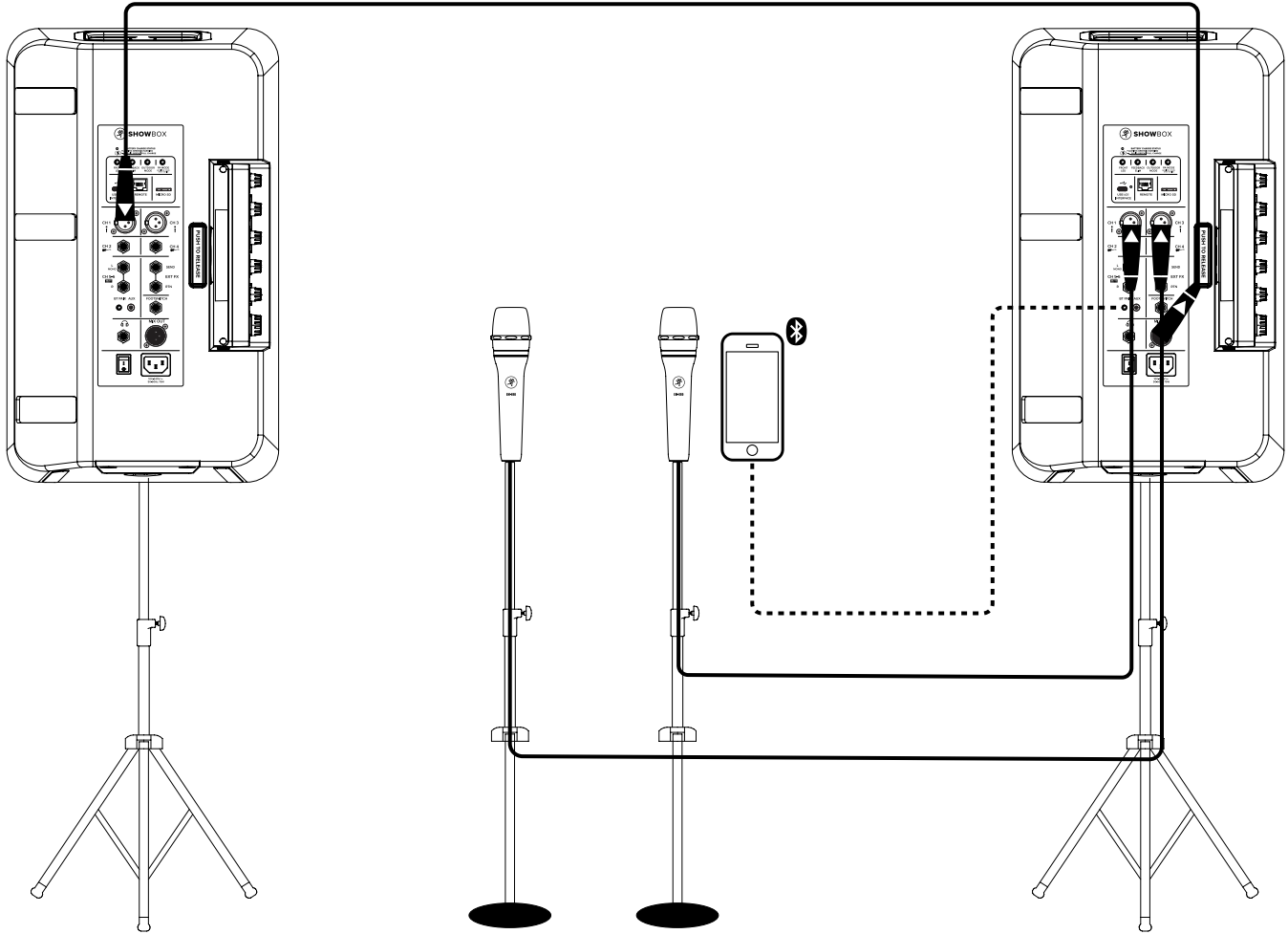

ShowBox is a great tool for singer-songwriters, buskers, full bands, karaoke enthusiasts, and much more!

In this example, our karaoke enthusiasts connect their trusty Mackie EM-89D dynamic microphones into the channel 1 and channel 3 XLR inputs. From here, set up the channel 1 and 3 inputs as you see fit. This includes the gain/volume levels, EQ settings, compressor level, FX (1 and 2), and more! Additionally, a phone is connected via Bluetooth for the heated karaoke matches! An XLR cable connects the primary ShowBox to an additional one... a stereo pair with massive power!

As seen in the previous pages, there are a multitude of other features that may be utilized in all three of these hookup diagrams. For example, the performance may be livestreamed via the USB-C connection and/or recorded directly to micro SD card. A subwoofer (or additional ShowBox) may be connected to the mix out jack (see above!). A phone or tablet can be connected to ShowBox via Bluetooth for playback (see above!)

Hookup Diagrams > Bands

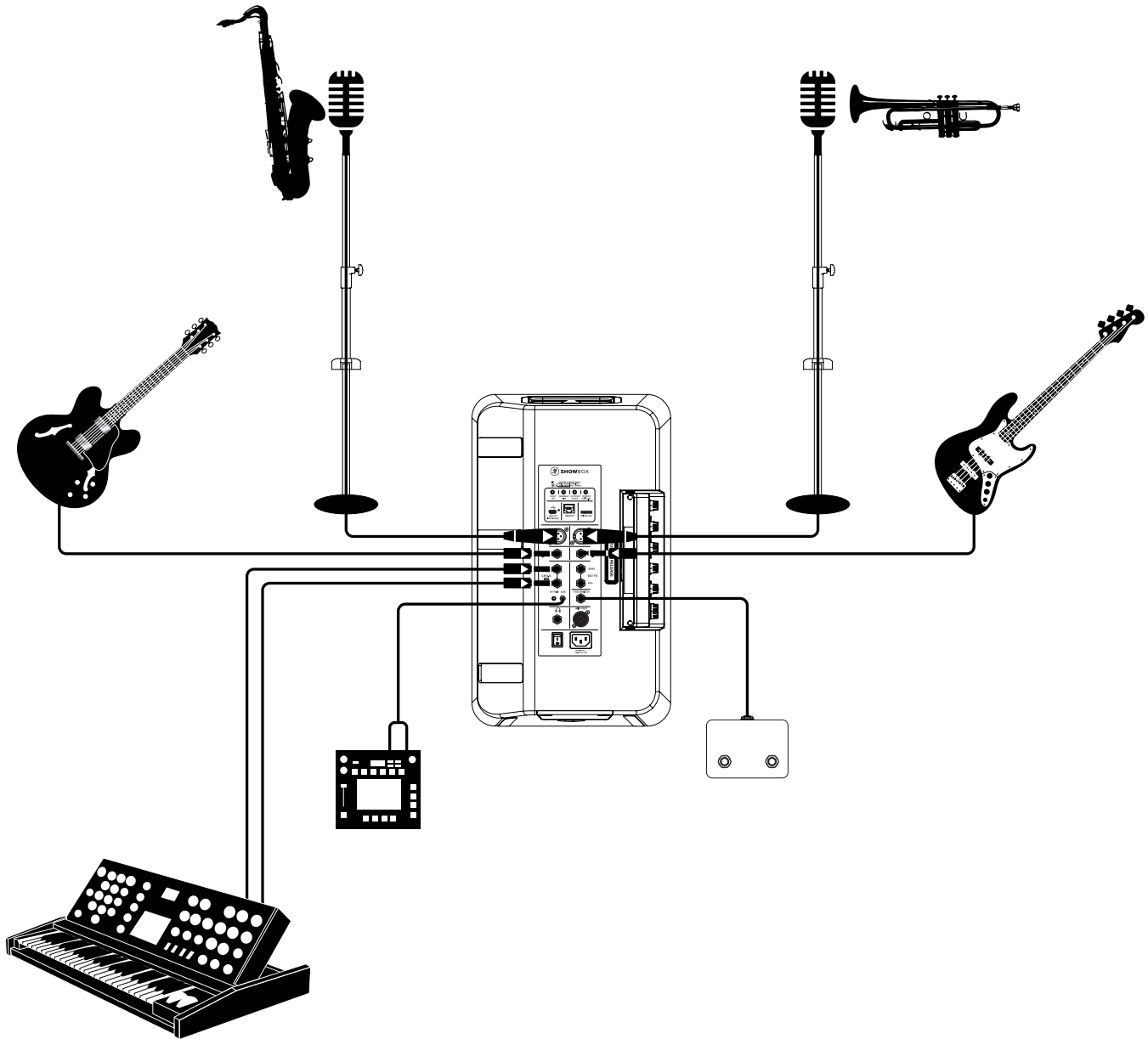

ShowBox is a great tool for singer-songwriters, buskers, full bands, karaoke enthusiasts, and much more!

In this example, we've got a funk band that wants to lay the stank! Two mics are connected to the channel 1 and 3 XLR inputs for the horn section. The six-string slinger is connected to the channel 2 input, while the low-end bass man is connected to the channel 4 input. A synthesizer is connected to the channel 5-6 stereo jacks, and a drum machine to the 1/8" aux input. Lastly, a footswitch is connected to the footswitch jack in order to turn FX on and off, as well as add loops. From here, set up all channel inputs as you see fit. This includes the gain/volume levels, EQ settings, compressor level, FX (1 and 2), and more!

As seen in the previous pages, there are a multitude of other features that may be utilized in all three of these hookup diagrams. For example, the performance may be livestreamed via the USB-C connection and/or recorded directly to micro SD card. A subwoofer (or additional ShowBox) may be connected to the mix out jack. Are guitar pedals being added to the mix? If so, they can be routed via the external FX send and return jacks. A phone or tablet can be connected to ShowBox via Bluetooth for playback [i.e. put it in PA mode and play tunes through it while setting up (and tearing down) equipment].

...and lest we forget, before beginning the performance, be sure to utilize the ShowBox's tuner feature!

Hookup Diagrams > Daisy-Chaining

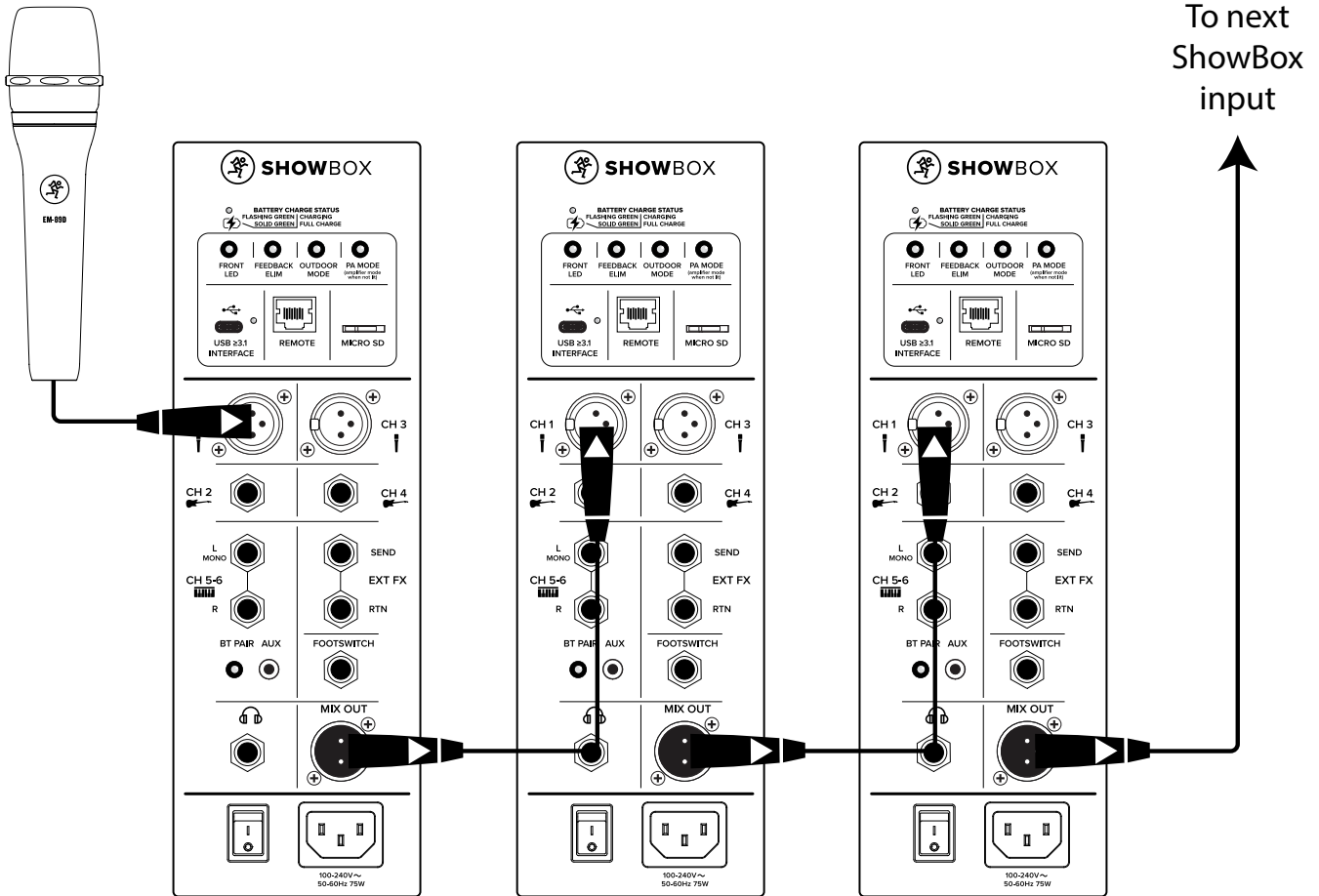

ShowBox may be daisy-chained via the male XLR connector labeled “MIX OUT”. Simply plug the signal source(s) (e.g. microphone above) into the input jack(s), and patch that ShowBox’s mix out jack to the next ShowBox’s input jack, and so on, daisy-chaining multiple ShowBoxes together. See above for visual representations of daisy-chaining.

## Appendix A : Service Information

---

### Troubleshooting

If you think your Mackie product has a problem, please check out the following troubleshooting tips and do your best to confirm the problem. Visit the Support section of our website ([www.mackie.com](http://www.mackie.com)) to get some ideas or contact our technical support heroes. You may find the answer to the problem without having to send your Mackie product away.

Here are some useful tips that could correct any of the issues outlined below (or possibly any other issue that we haven't yet discovered):

**Getting Started:** If you are having any sound (or non-sound) issues, try following the level setting procedure as outlined on page 7 to verify that all of the volume controls in the system are properly adjusted.

There are no user serviceable parts. If none of these tips work, please refer to "Repair" on the next page to find out how to proceed.

### No Power

- Our favorite question. Is it plugged in (whether by power cord or battery)?
- Our favorite follow-up question. If using a battery, is it fully charged? Are you sure?!
- Another favorite. Is the rear panel power switch in the ON position?
- Are all the lights out in town? If so, contact the local power company to get power restored.

### No Sound

- Are all the connections good and sound? Make sure all of the connecting cables work and are securely connected at both ends. Try the same source signal in another channel, set up exactly like the suspect channel.
- Is the signal source powered on? Is it working (and making union scale)?

### Noise / Hum

- Are you using unbalanced cables? Swap them out with balanced cables to see if that fixes the problem.
- Turn the input gains down one-by-one. If the offending noise disappears, it's either that input or whatever is plugged into it. If you unplug the whatever-is-plugged-into-it and turn the input gain back up and the noise is gone, it's from your whatever.
- Sometimes it helps to plug all the audio equipment into the same AC circuit so they share a common ground. Make it so.



## Other Issues

- Bluetooth Blues?
  - Restart the Bluetooth device. Completely power it down, then power it back up.
  - Restart ShowBox. A simple reboot can sometimes work great wonders.
  - Please email or call Technical Support if you are having any other issue not listed here:
    - o [mackie.com/support-contact](http://mackie.com/support-contact)
    - o 1-800-898-3211

## Repair

For warranty service, refer to the warranty information on page 50.

Non-warranty service for Mackie products is available at a factory-authorized service center. To locate the nearest service center, visit [www.mackie.com](http://www.mackie.com), click “Support” and select “Service Center Locator”. Service for Mackie products living outside the United States can be obtained through local dealers or distributors.

If you do not have access to our website, you can call our Tech Support department at 1-800-898-3211, Monday-Friday during normal business hours, Pacific Time, to explain the problem. Tech Support will tell you where the nearest factory-authorized service center is located in your area.

## Appendix B : Technical Information

### Specifications

#### Acoustic Performance

Frequency Response (-10 dB): ..... 48 Hz – 20 kHz  
 Frequency Response (-3 dB): ..... 55 Hz – 20 kHz

Horizontal Coverage: ..... 90°  
 Vertical Coverage: ..... 60°

Maximum SPL Peak: ..... 122 dB

Monitor Angle: ..... 45°

#### Transducers

Low Frequency: ..... 8 in / 203 mm woofer with ferrite

High Frequency: ..... 1.0 in / 25 mm polymer compression driver

#### Power Amplifiers

##### System Power Amplification

Rated Power: ..... 400 watts peak

##### Low Frequency Power Amplifier

Rated Power: ..... 350 watts peak

Rated THD: ..... <1%

Cooling: ..... Convection

Design: ..... Class D

##### High Frequency Power Amplifier

Rated Power: ..... 50 watts peak

Rated THD: ..... <1%

Cooling: ..... Convection

Design: ..... Class D

#### Donuts

A Baker's Dozen: ..... Powdered, frosted, sprinkled, old-fashioned, Boston Cream,  
 maple bar, apple fritter, cinnamon roll, glazed, jelly

Donut Holes : ..... Original, cinnamon, chocolate, powdered

**Input / Output**

---

Input Type: ..... 2x Female XLR jacks, 4x 1/4" balanced jacks,  
1/8" Aux jack, Bluetooth, USB-C

Mic Impedance [Channels 1 + 3]: ..... 4 k $\Omega$  balanced

Instrument Impedance [Channels 2 + 4]: ..... 1 M $\Omega$  unbalanced

Line Input [Channel 5/6]: ..... 10 k $\Omega$  balanced/unbalanced

Output Type: ..... Male XLR balanced [Mix Out],  
Stereo Headphones

Mix Out Impedance: ..... 300  $\Omega$  balanced

FX Send Impedance: ..... 300  $\Omega$  pseudo-balanced

**Bluetooth and USB Information**

---

Bluetooth Protocol: ..... 5.1

Bluetooth Function: ..... Audio Streaming

USB : ..... 2x2

**Electronic Crossover**

---

Crossover Type: ..... 4th order Linkwitz-Riley set at 1.8 kHz

Crossover Frequency: ..... 2.0 kHz

**Equalization**

---

Low: .....  $\pm 15$  dB @ 80 Hz

Mid: .....  $\pm 15$  dB @ 2.5 kHz

High: .....  $\pm 15$  dB @ 12 kHz

**Digital Effects**

---

FX1 Presets: ..... 12 – refer to pages 24-25, 47-48 for more information

FX2 Presets: ..... 16 – refer to pages 24-25, 47-48 for more information

**Power Requirements**

Power Connector ..... 100–240V~, 50–60 Hz, 75W

Battery Type ..... Lithium Ion

Battery Technology ..... 5200mAh, 14.8 V

Battery Life ..... Up to 12 hours

Charge Time ..... 3 hours (no signal),  
4 hours (with signal)

Operating Temperature: ..... 0–45° C // 32–113° F

**Safety Features**

Input Protection: ..... Peak and RMS limiting, power supply  
and amplifier thermal protection

Display LEDs: ..... Front LEDs, Feedback Eliminator, Outdoor Mode, PA Mode,  
Bluetooth Status, Battery Level, Breakaway Mixer (Multiple)

**Options**

ShowBox Backpack: ..... P/N 2056473

ShowBox Spare Battery: ..... P/N 2053625

ShowBox Footswitch + Cable: ..... P/N 2056472

T100 Tripod Stand: ..... P/N 2052464

SPM200 Unthreaded Pole Mount: ..... P/N 2035170

SPM400 Threaded Pole Mount: ..... P/N 2051055

**Dimensions**

Size (H x W x D): ..... 19.7 × 11.8 × 9.8 in // 500 × 300 × 249 mm

Weight: ..... 20.9 lb // 9.5 kg

**About**

Part Number, Rev and Date: ..... SW1434, Rev A, December 2023

LOUD Audio, LLC. is always striving to improve our products by incorporating new and improved materials, components, and manufacturing methods. Therefore, we reserve the right to change these specifications at any time without notice. The “Running Man” is a registered trademark of LOUD Audio, LLC. All other brand names mentioned are trademarks or registered trademarks of their respective holders, and are hereby acknowledged.

Please check our website for any updates to this Owner’s Manual: [www.mackie.com](http://www.mackie.com).  
©2023 LOUD Audio, LLC. All right All right All rights reserved.

ShowBox Dimensions

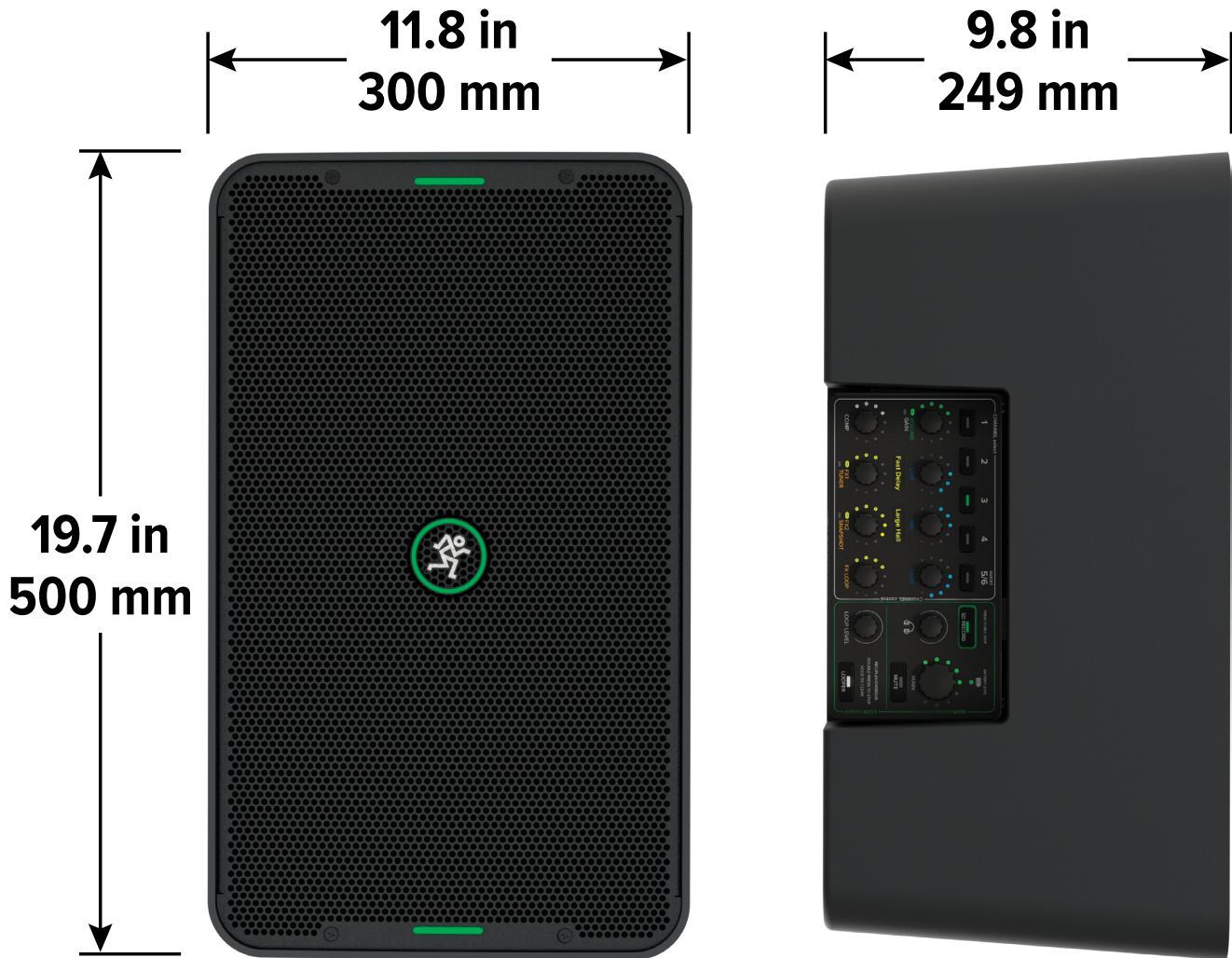

**WEIGHT**  
20.9 lb / 9.5 kg

ShowBox Block Diagram

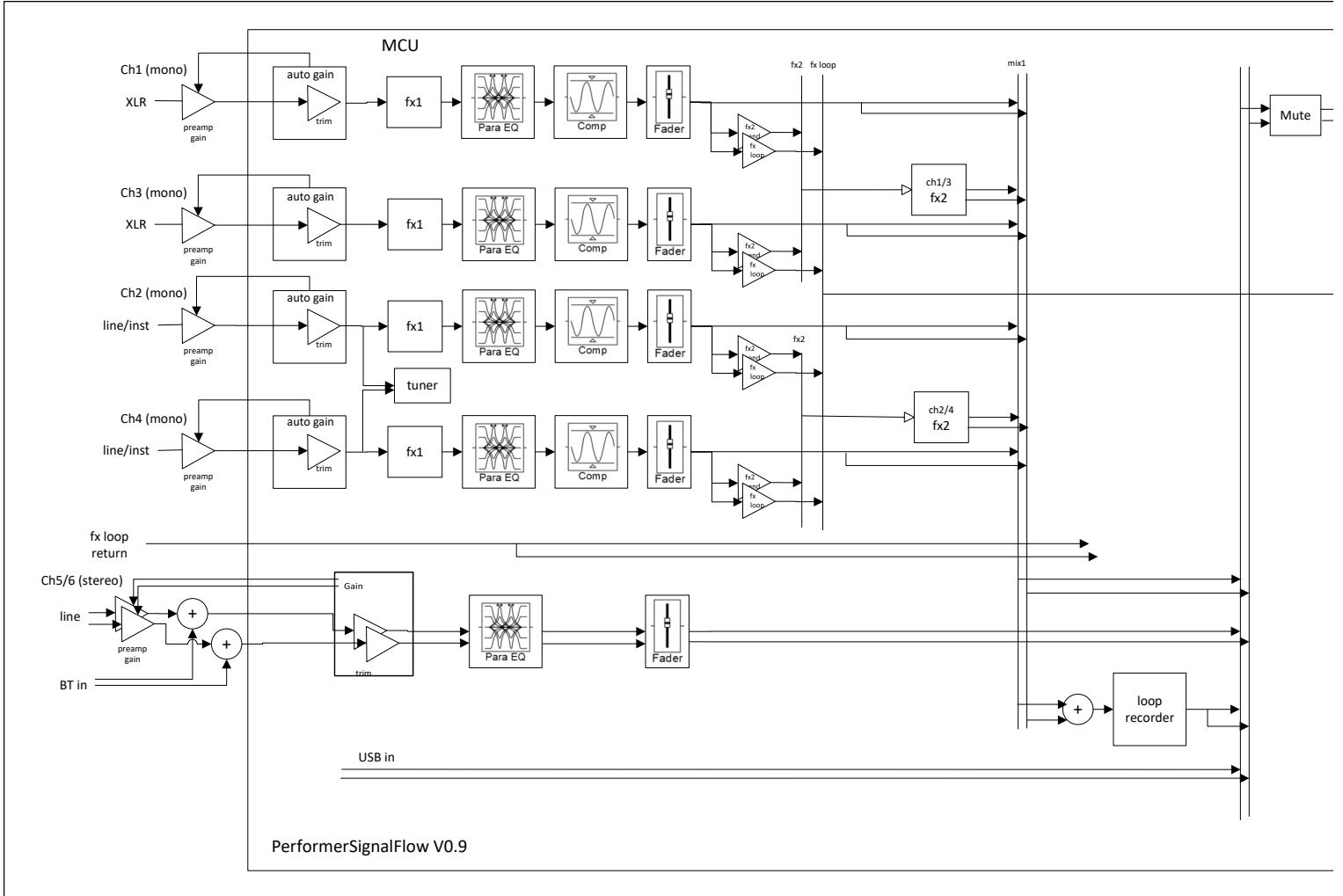

# SHOWBOX BATTERY POWERED ALL-IN-ONE PERFORMANCE RIG WITH BREAKAWAY MIX CONTROL

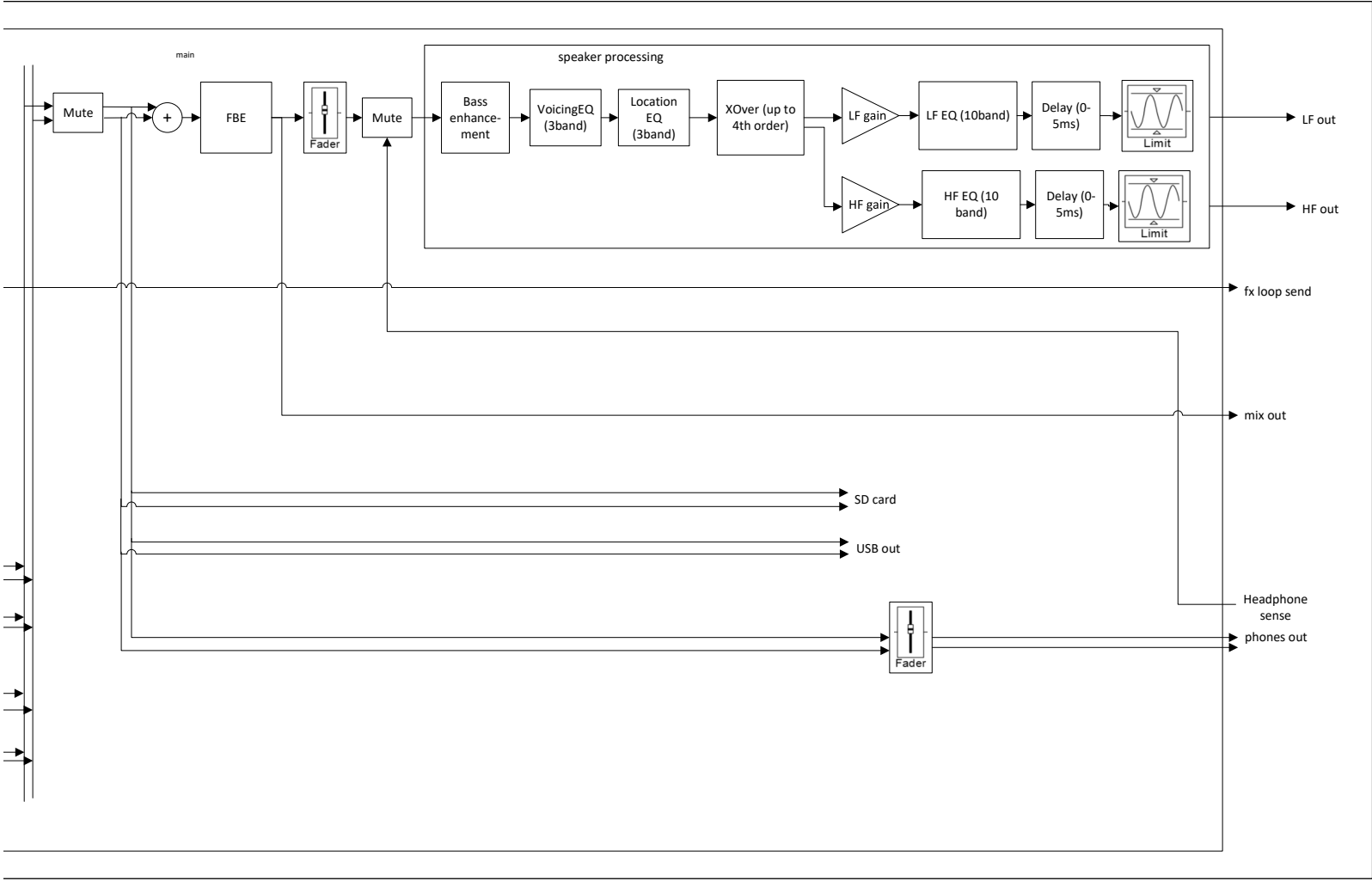

## Appendix C : Table of Effects Presets

Effects that are available in both FX1 + FX2 – small/large chorus, fast/slow delay, delay + chorus, reverse delay, flanger, phaser, and tremolo – may be “stacked”, if so inclined. In other words, one of the instrument channels could essentially “stack” two flangers or phasers to really fatten up the sound (and effect). Play around with the different effects and “stacking” them. Works great with vocals, too!

Effect	Description	Example of its use
SMALL CHORUS (FX1 + FX2) LARGE CHORUS (FX1 + FX2)	These effects provide a soft, ethereal sweeping effect that is useful for thickening and for making a particular sound pop out of the mix.	Perfect for enhancement of electric and acoustic guitar and bass, or to add a dramatic effect to vocals, particularly group harmonies and choirs.
FAST DELAY (FX1 + FX2) SLOW DELAY (FX1 + FX2)	These two effects provide delay with delay times of fast and slow.	These work best with full, up-beat music like rock where the delay needs to cut through the mix.
DELAY + CHORUS (FX1 + FX2)	Delay + chorus combined as one adds rich, warm character, but with modulated tails of delay.	Pink Floyd guitarist, David Gilmour, often used this effect in his setup.
OVERDRIVE (FX1)	This effect increases the gain, resulting in a “fuzzy” – overdriven / distorted – tone. The tone is clipped, but not too much. It is a “smooth, mellow grit”.	The late, great Stevie Ray Vaughn used overdrive quite a bit on his albums.
FUZZ (FX1)	This setting appears to make the ShowBox sound faulty or damaged. It is not. The harmonic overtones dominate the sound and the signal is absolutely clipped.	A lot of heavy rock and metal bands employ fuzz. Some blues and psychedelic artists, as well. Jimi Hendrix and Billy Corgan (Smashing Pumpkins) were frequent users.
CRUNCH (FX1)	Crunch has more sustain than a clean tone but less gain than overdrive or fuzz.	Crunch is the perfect effect for rhythm guitar, with a moderate amount of overdrive.
CAT’S MEOW	This effect will make your voice and/or instrument sound like a cat’s meow (at the sang / played pitch, of course).	This effect is especially useful for gigs at House of Cats, Royal Catbert Hall, Saturday Night Live, Red Cats, Seattle’s Showbox, and let’s not forget the local fish market.
FLANGER (FX1 + FX2)	The flange effect is a modulated delay with feedback (and shorter delay times than a chorus), which creates the characteristic “whooshing” sound often used to describe the flange sound.	Check out Heart’s “Barracuda”!
PHASER (FX1 + FX2)	The phaser uses a series of all pass filters to alter the phase of the signal so that when it adds to the dry signal, you get notches in the output.	Guitarist King Edward (R.I.P.) used a phaser all over the early Van Halen albums.
TUBE MODEL (FX1)	ShowBox is considered a “solid state” amp as it doesn’t have tubes. This effect essentially “models” a tube model amplifier.	Many musicians throughout history have used tube amps on their recordings, live performances, and more.
TREMOLO (FX1 + FX2)	The tremolo effect produces a slight, rapid variation in loudness. i.e. volume modulation  [Not to be confused with a guitar’s tremolo bar which fluctuates the pitch of the sound, not the volume.]	Green Day – Boulevard of Broken Dreams, Audioslave – Like a Stone and many more.



Effect	Description	Example of its use
SMALL CHORUS (FX1 + FX2) LARGE CHORUS (FX1 + FX2)	These effects provide a soft, ethereal sweeping effect that is useful for thickening and for making a particular sound pop out of the mix.	Perfect for enhancement of electric and acoustic guitar and bass, or to add a dramatic effect to vocals, particularly group harmonies and choirs.
FAST DELAY (FX1 + FX2) SLOW DELAY (FX1 + FX2)	These two effects provide delay with delay times of fast and slow.	These work best with full, up-beat music like rock where the delay needs to cut through the mix.
DELAY + CHORUS (FX1 + FX2)	Delay + chorus combined as one adds rich, warm character, but with modulated tails of delay.	Pink Floyd guitarist, David Gilmour, often used this effect in his setup.
FLANGER (FX1 + FX2)	The flange effect is a modulated delay with feedback (and shorter delay times than a chorus), which creates the characteristic “whooshing” sound often used to describe the flange sound.	Check out Heart’s “Barracuda”!
PHASER (FX1 + FX2)	The phaser uses a series of all pass filters to alter the phase of the signal so that when it adds to the dry signal, you get notches in the output.	Guitarist King Edward (R.I.P.) used a phaser all over the early Van Halen albums.
TREMOLO (FX1 + FX2)	The tremolo effect produces a slight, rapid variation in loudness. i.e. volume modulation  [Not to be confused with a guitar’s tremolo bar which fluctuates the pitch of the sound, not the volume.]	Green Day – Boulevard of Broken Dreams, Audioslave – Like a Stone and many more.
SMALL PLATE (FX2) LARGE PLATE (FX2)	Plate reverbs emulate vintage mechanical reverberation that is generated with a metal plate. Its sound is characterized by lots of early reflections and no pre-delay.	Perfect for adding a long sustain to percussion such as tambourine or hand-claps, or thickening backup vocals or other tight vocal arrangements.
SMALL ROOM (FX2)	The small room reverb simulates the reverberation (persistence of sound) in a typical small room. Small rooms are typically coined “dead” rooms with little to no reverb.	Some artists record guitars (and/or bass) from a bathroom to get a “punchier” sound out of their amp.
LARGE ROOM (FX2)	The large room reverb simulates the reverberation (persistence of sound) in a typical large room. Large rooms are typically coined “live” rooms since they have a lot of reverb.	Sound tends to carry in large rooms with a lot of open space. This works well for a good, boomy, deep sound.
SMALL HALL (FX2) LARGE HALL (FX2)	These reverbs simulate the sound of a spacious, yet cozy, heavily draped and carpeted hall with an especially warm tone.	These reverbs should be chosen when trying to “thicken up” and/or add “space” to a song (or passage). Think “music hall” or “symphonic hall”.
SPRING REVERB (FX2)	A spring reverb uses a transducer at one end of a spring and a pickup at the other end to create and capture vibrations in a metal spring. The longer the spring, the longer the decay time of the reverberation.	A touch of spring reverb adds to the ambience of a song. This is a great choice when taking a guitar solo.
DELAY + REVERB	Delay + reverb combined as one allows for more sustained delays with confident tones and ambience.	Useful for bands that employ the alternative rock, shoegaze and/or experimental rock sound.

Effect	Description	Example of its use
**REVERSE DELAY (FX1 + FX2)	A reverse delay takes the instrument input signal, momentarily delays it, then sends the reversed signal (of the input) to the output.	Jimi Hendrix and The Beatles perfected the sound, but for a more recent suggestion, check out ‘Stolen’ by Dashboard Confessional.
** ACOUSTIC GUITAR SIMULATOR (FX1)	Simply put, the acoustic guitar simulator makes a standard electric guitar sound like an acoustic-electric.	This is the setting to choose if you only have an electric guitar, but need it to sound like an acoustic.
**These FX are available only on channels 2 and 4.		

## Warranty Statement

### Please keep your sales receipt in a safe place.

This Limited Product Warranty ("Product Warranty") is provided by LOUD Audio, LLC. ("LOUD") and is applicable to products purchased in the United States or Canada through a LOUD-authorized reseller or dealer. The Product Warranty will not extend to anyone other than the original purchaser of the product (hereinafter, "Customer," "you" or "your").

For products purchased outside the U.S. or Canada, please visit [www.mackie.com/warranty](http://www.mackie.com/warranty) to find contact information for your local distributor, and information on any warranty coverage provided by the distributor in your local market.

LOUD warrants to Customer that the product will be free from defects in materials and workmanship under normal use during the Warranty Period. If the product fails to conform to the warranty then LOUD or its authorized service representative will at its option, either repair or replace any such nonconforming product, provided that Customer gives notice of the noncompliance within the Warranty Period to the Company at: [www.mackie.com/support](http://www.mackie.com/support) or by calling LOUD technical support at 1.800.898.3211 (toll-free in the U.S. and Canada) during normal business hours Pacific Time, excluding weekends or LOUD holidays. Please retain the original dated sales receipt as evidence of the date of purchase. You will need it to obtain any warranty service.

For full terms and conditions, as well as the specific duration of the Warranty for this product, please visit [www.mackie.com/warranty](http://www.mackie.com/warranty).

The Product Warranty, together with your invoice or receipt, and the terms and conditions located at [www.mackie.com/warranty](http://www.mackie.com/warranty) constitutes the entire agreement, and supersedes any and all prior agreements between LOUD and Customer related to the subject matter hereof. No amendment, modification or waiver of any of the provisions of this Product Warranty will be valid unless set forth in a written instrument signed by the party to be bound thereby.

### Need help with ShowBox?

- Visit [www.mackie.com/support](http://www.mackie.com/support) to find: FAQs, manuals, addendums, and other documents.
- Email us at: [www.mackie.com/support-contact](http://www.mackie.com/support-contact)
- Telephone 1-800-898-3211 to speak with one of our splendid technical support chaps (Monday through Friday, normal business hours, Pacific Time).

**Please write the serial numbers here for future reference (i.e., insurance claims, tech support, return authorization, make dad proud, etc.)**

**Purchased at:**

**Date of purchase:**



19820 North Creek Parkway #201, Bothell, WA 98011 • USA  
Phone: 425.487.4333 • Toll-free: 800.898.3211  
Fax: 425.487.4337 • [www.mackie.com](http://www.mackie.com)

